

**MAX274 Evaluation Kit &
MAX274/275 Software Manuals
Follow Datasheet**



4th- and 8th-Order Continuous-Time Active Filters

General Description

The MAX274 and MAX275 are continuous-time active filters consisting of independent cascadable 2nd-order sections. Each section can implement any all-pole bandpass or lowpass filter response, such as Butterworth, Bessel, and Chebyshev, and is programmed by four external resistors. The MAX274/MAX275 provide lower noise than switched-capacitor filters, as well as superior dynamic performance - both due to the continuous-time design. Since continuous-time filters do not require a clock, aliased and clock noise are eliminated with the MAX274/MAX275.

The MAX274 comprises four 2nd-order sections, permitting 8th-order filters to be realized. Center frequencies range up to 150kHz, and are accurate to within $\pm 1\%$ over the full operating temperature range. Total harmonic distortion (THD) is typically better than -89dB

The MAX275 comprises two 2nd-order sections, permitting 4th-order filters to be realized. Center frequencies range up to 300kHz, and are accurate to within $\pm 0.9\%$ over the full operating temperature range. Total harmonic distortion (THD) is typically better than -86dB

Both filters operate from a single +5V supply or from dual $\pm 5V$ supplies

Applications

- Low-Distortion Anti-Aliasing Filters
- DAC Output Smoothing Filters
- Modems
- Audio/Sonar/Avionics Frequency Filtering
- Vibration Analysis

Pin Configurations

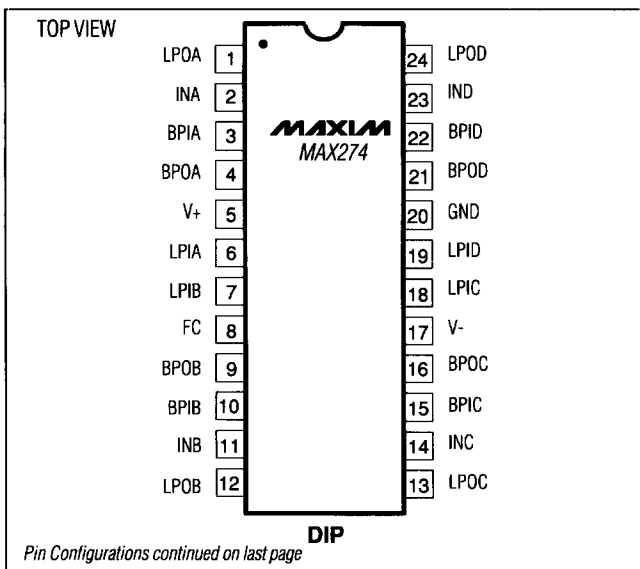

Features

- ◆ Continuous-Time Filter - No Clock, No Clock Noise
- ◆ Implement Butterworth, Chebyshev, Bessel and Other Filter Responses
- ◆ Lowpass, Bandpass Outputs
- ◆ Operate from a Single +5V Supply or Dual $\pm 5V$ Supplies
- ◆ Design Software Available
- ◆ MAX274 Evaluation Kit Available
- ◆ 8th-Order - Four 2nd-Order Sections (MAX274)
4th-Order - Two 2nd-Order Sections (MAX275)
- ◆ Center-Frequency Range:
150kHz for MAX274
300kHz for MAX275
- ◆ Low Noise: -86dB THD Typical for MAX274
-89dB THD Typical for MAX275
- ◆ Center-Frequency Accurate Over Temp:
within $\pm 1\%$ for MAX274
within $\pm 0.9\%$ for MAX275

Ordering Information

PART	TEMP. RANGE	PIN-PACKAGE
MAX274ACNG	0°C to +70°C	24 Narrow Plastic DIP
MAX274BCNG	0°C to +70°C	24 Narrow Plastic DIP
MAX274ACWI	0°C to +70°C	28 Wide SO
MAX274BCWI	0°C to +70°C	28 Wide SO
MAX274BC/D	0°C to +70°C	Dice*

Ordering Information continued on last page

* Contact factory for dice specifications.

Typical Operating Circuits

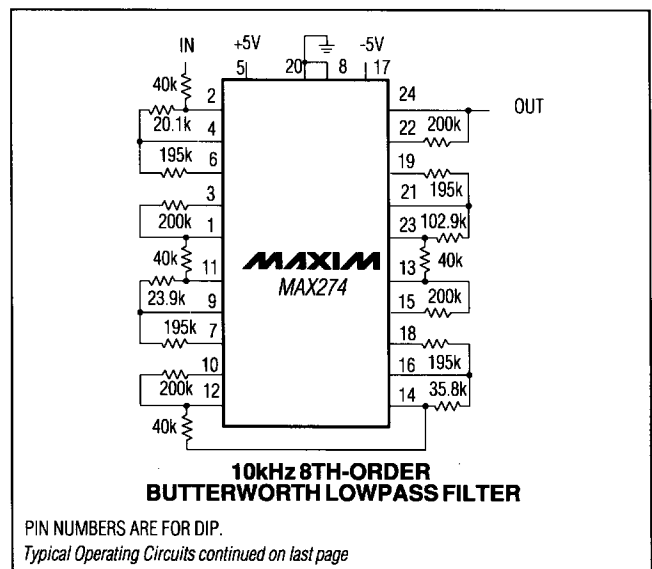

4th- and 8th-Order Continuous-Time Active Filters

ABSOLUTE MAXIMUM RATINGS

V+ to V- -0.3V, 12V
 Input Voltage to GND (any input) V- - 0.3V, V+ + 0.3V
 Continuous Power Dissipation (TA = +70°C)

MAX274

24-Pin Narrow Plastic DIP
 (derate 13.33mW/°C above +70°C) . . . 1067mW
 28-Pin Wide SO (derate 12.50mW/°C above +70°) . 1000mW
 24-Pin CERDIP (derate 12.50mW/°C above +70°C) . 1000mW

MAX275

20-Pin Plastic DIP(derate 11.11mW/°C above +70°C) 889mW
 20-Pin Wide SO (derate 10.00mW/°C above +70°) . . 800mW
 20-Pin CERDIP (derate 11.11mW/°C above +70°C) . . 889mW

Operating Temperature Ranges:

MAX27__C__ 0°C to +70°C
 MAX27__E__ -40°C to +85°C
 MAX27__MRG -55°C to +125°C
 Storage Temperature Range -65°C to +165°C
 Lead Temperature (soldering, 10 sec) +300°C

Stresses beyond those listed under "Absolute Maximum Ratings" may cause permanent damage to the device. These are stress ratings only, and functional operation of the device at these or any other conditions beyond those indicated in the operational sections of the specifications is not implied. Exposure to absolute maximum rating conditions for extended periods may affect device reliability.

ELECTRICAL CHARACTERISTICS – MAX274

(V+ = 5V, V- = -5V, test circuit A of Figure 1a, TA = TMIN to TMAX, unless otherwise noted.)

PARAMETER	SYMBOL	CONDITIONS		MIN	TYP	MAX	UNITS
FILTER CHARACTERISTICS							
Maximum Operating Frequency					10		MHz
Center-Frequency Range	F ₀	(Note 1)			100 to 150k		Hz
Center-Frequency Accuracy	F ₀		MAX274A	-1.0		1.0	%
			MAX274B	-1.4		1.4	
Q Accuracy - Unadjusted			MAX274A	-10		10	%
			MAX274B	-15		15	
Q Accuracy - Adjusted		Scaled for bandwidth compensation			±2.8		%
F ₀ Temperature Coefficient	ΔF ₀ /ΔT	(Note 2)			-28		ppm/°C
Q Temperature Coefficient	ΔQ/ΔT	(Note 2)			160		ppm/°C
Wideband Noise	V _{NOISE}	LPO_, Figure 1a, test circuit B	1Hz to 10Hz		23		μVRMS
			10Hz to 10kHz		120		
DC CHARACTERISTICS							
DC Lowpass Gain Accuracy	H _{OLP}	Assume ideal resistors	MAX274A	-2		2	%
			MAX274B	-3		3	
Offset Voltage at Outputs	V _{OS}	LPO_	MAX274A	-200		200	mV
			MAX274B	-300		300	
		BPO_	MAX274A	-40		40	
			MAX274B	-80		80	
Offset Voltage Drift	ΔV _{OS} /ΔT				20		μV/°C
Leakage Current at FC Pin	I _{FC}			-10		10	μA
DYNAMIC FILTER CHARACTERISTICS							
Signal-to-Noise plus Distortion	SINAD	F _{TEST} = 1kHz, Figure 1a, test circuit B	LPO_, V _{LPO} = 8Vp-p		-86		dB
				F _{TEST} = 10kHz, Figure 1a, test circuit C		-82	

4th- and 8th-Order Continuous-Time Active Filters

MAX274/MAX275/Software/EV Kit

ELECTRICAL CHARACTERISTICS (continued) – MAX274

(V+ = 5V, V- = -5V, test circuit A of Figure 1a, TA = TMIN to TMAX, unless otherwise noted.)

PARAMETER	SYMBOL	CONDITIONS	MIN	TYP	MAX	UNITS
Output Voltage Swing	VOUT	LPO_, BPO_, RLOAD = 5kΩ	±3.25	±4.50		V
Slew Rate	SR			10		V/μs
Gain-Bandwidth Product	GBW			7.5		MHz
POWER REQUIREMENTS						
Supply Voltage Range	VSUPP	(Note 3)	±2.37		±5.50	V
Supply Current	IC	For V+, V-		20	30	mA
Power-Supply Rejection Ratio	PSRR	V+ = 5V + 100mVp-p at 1kHz, V- = -5V		-30		dB

Note 1: Center frequencies (F0s) below 100Hz are possible at reduced dynamic range.

Note 2: Assume no drift for external resistors.

Note 3: See Figure 9 for single-supply operation.

ELECTRICAL CHARACTERISTICS – MAX275

(V+ = 5V, V- = -5V, test circuit A of Figure 1b, TA = TMIN to TMAX, unless otherwise noted.)

PARAMETER	SYMBOL	CONDITIONS	MIN	TYP	MAX	UNITS
FILTER CHARACTERISTICS						
Maximum Operating Frequency				10		MHz
Center-Frequency Range	F0	(Note 1)		100 to 300k		Hz
Center-Frequency Accuracy	F0		MAX275A	-0.9	0.9	%
			MAX275B	-1.4	1.4	
Q Accuracy – Unadjusted			MAX275A	-8	8	%
			MAX275B	-12	12	
Q Accuracy – Adjusted		Scaled for bandwidth compensation		±1		%
F0 Temperature Coefficient	ΔF0/ΔT	(Note 2)		-24		ppm/°C
Q Temperature Coefficient	ΔQ/ΔT	(Note 2)		38		ppm/°C
Wideband Noise	VNOISE	LPO_, test circuit B of Figure 1b,	1Hz to 10Hz		6	μVRMS
			10Hz to 10kHz		42	
DC CHARACTERISTICS						
DC Lowpass Gain Accuracy	HOLP	Assume ideal resistors	MAX275A	-1	1	%
			MAX275B	-2	2	
Offset Voltage at Outputs	VOS	LPO_	MAX275A	-125	125	mV
			MAX275B	-250	250	
		BPO_	MAX275A	-50	50	
			MAX275B	-100	100	
Offset Voltage Drift	ΔVOS/ΔT			20		μV/°C
Leakage Current at FC Pin	IFC		-10		10	μA
DYNAMIC FILTER CHARACTERISTICS						
Signal-to-Noise plus Distortion	SINAD	FTEST = 1kHz, test circuit B of Figure 1b,	LPO_, VLPO = 8Vp-p		-89	dB
		FTEST = 10kHz, test circuit C of Figure 1b,			-83	

4th- and 8th-Order Continuous-Time Active Filters

ELECTRICAL CHARACTERISTICS (continued) – MAX275

(V+ = 5V, V- = -5V, test circuit A of Figure 1b, TA = TMIN to TMAX, unless otherwise noted.)

PARAMETER	SYMBOL	CONDITIONS	MIN	TYP	MAX	UNITS
Output Voltage Swing	VOUT	LPO_, BPO_, RLOAD = 5kΩ	±3.25	±4.50		V
Internal Amplifier Slew Rate	SR			10		V/μs
Gain-Bandwidth Product	GBW			15		MHz
POWER REQUIREMENTS						
Supply Voltage Range	VSUPP	(Note 3)	±2.37		±5.50	V
Supply Current	IC	For V+, V-		10	24	mA
Power-Supply Rejection Ratio	PSRR	V+ = 5V + 100mVp-p at 1kHz, V- = -5V		-35		dB

Note 1: Center frequencies (F0s) below 100Hz are possible at reduced dynamic range.

Note 2: Assume no drift for external resistors.

Note 3: See Figure 9 for single-supply operation.

Typical Operating Characteristics—MAX274

FILTER WIDEBAND RESPONSE USING TYPICAL OPERATING CIRCUIT

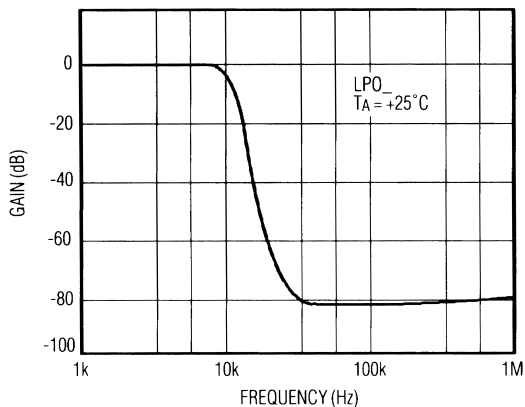

FILTER RESPONSE USING TYPICAL OPERATING CIRCUIT

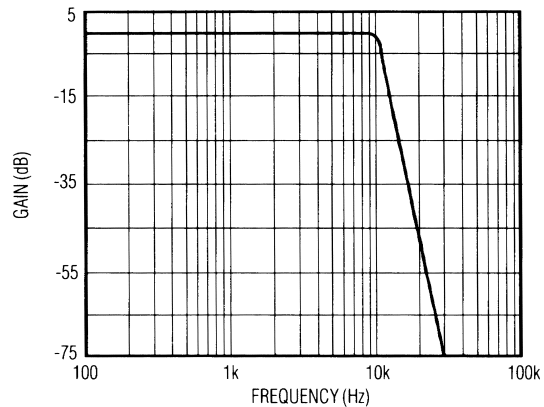

F0 ERROR vs. FREQUENCY

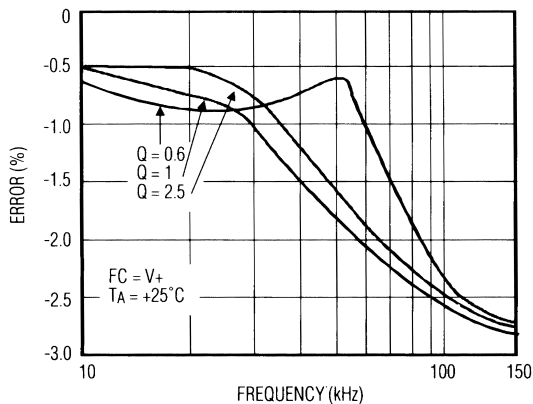

Q ERROR vs. FREQUENCY

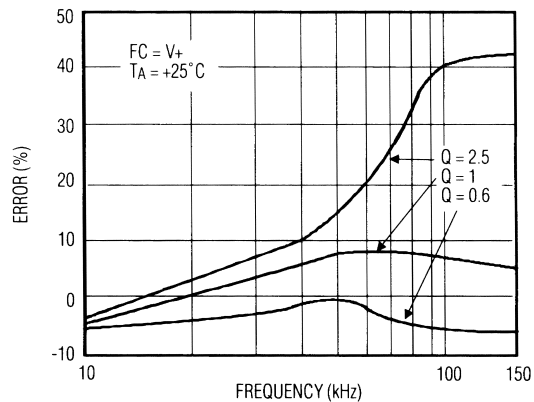

4th- and 8th-Order Continuous-Time Active Filters

Typical Operating Characteristics—MAX274 (continued)

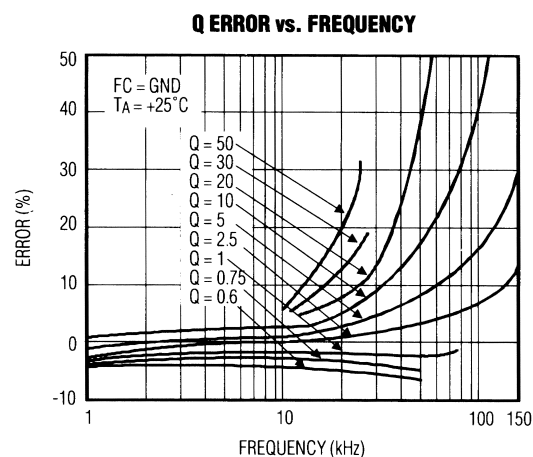
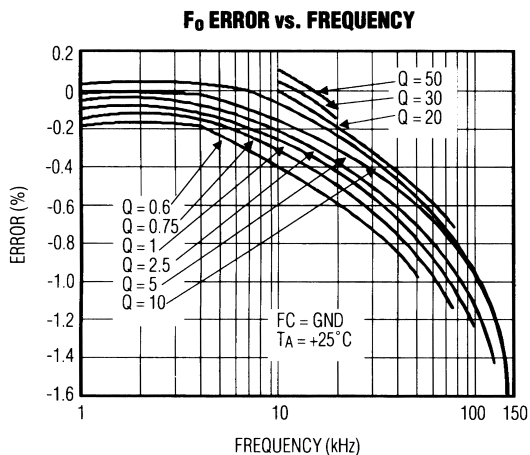
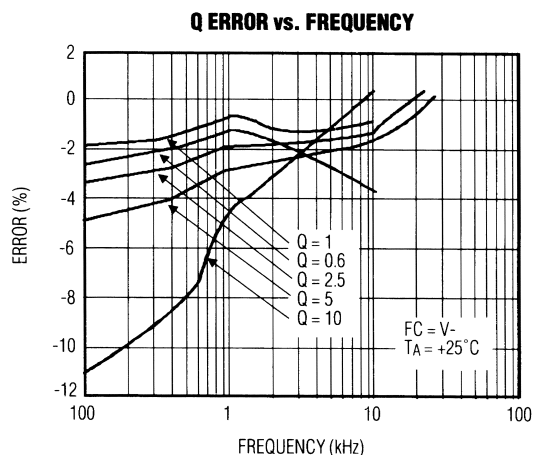
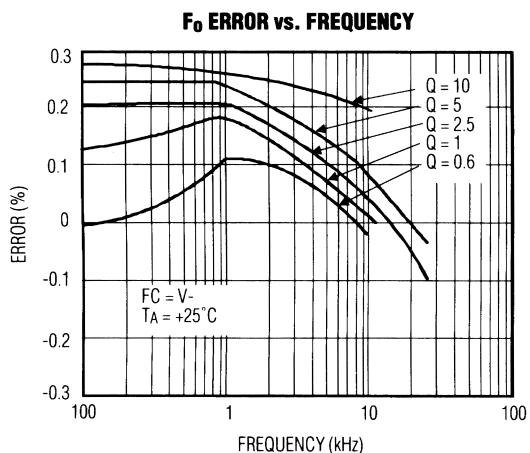

TYPICAL DISTRIBUTION OF CENTER-FREQUENCY ERRORS

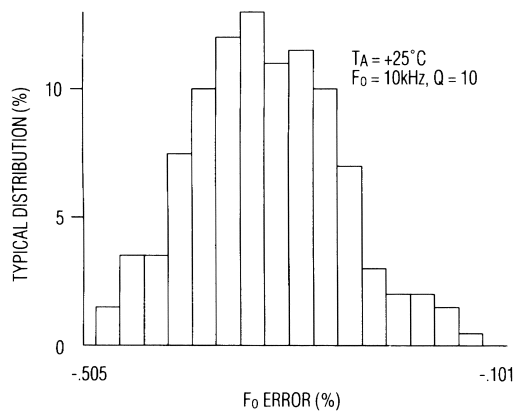

TYPICAL DISTRIBUTION OF Q ERRORS

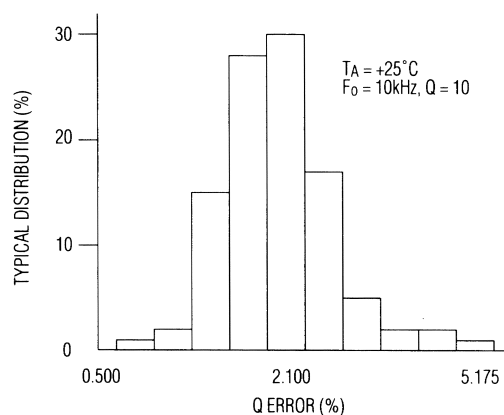

4th- and 8th-Order Continuous-Time Active Filters

Typical Operating Characteristics—MAX274 (continued)

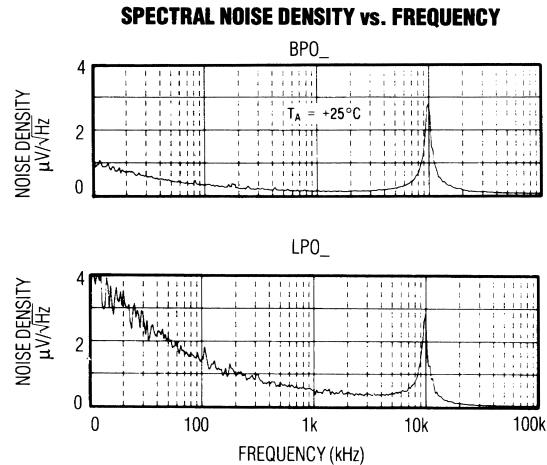
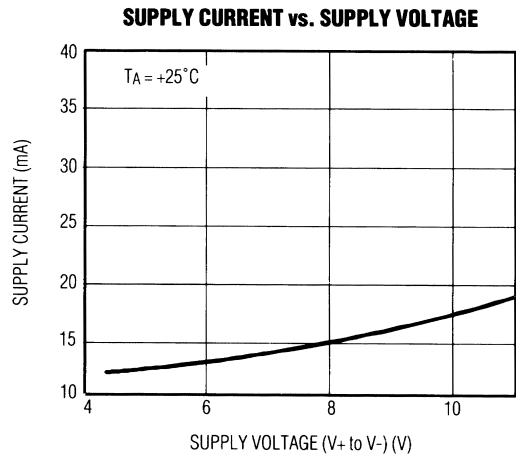
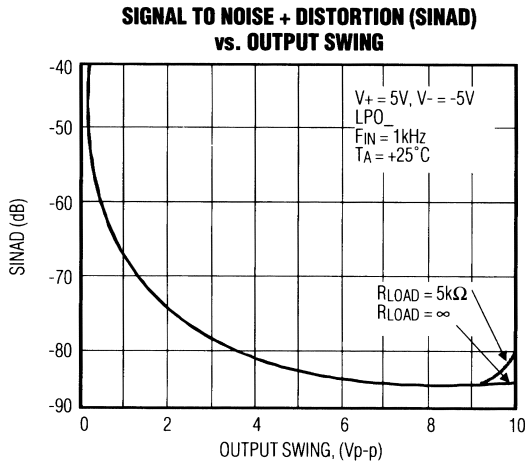
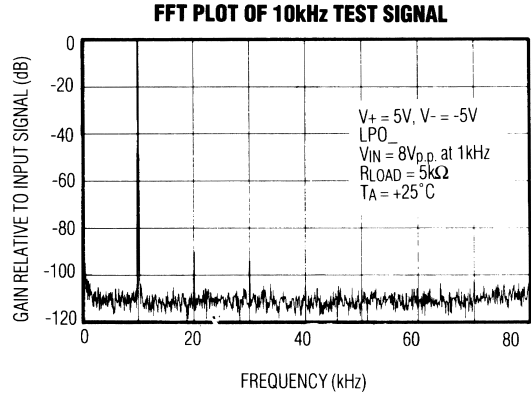
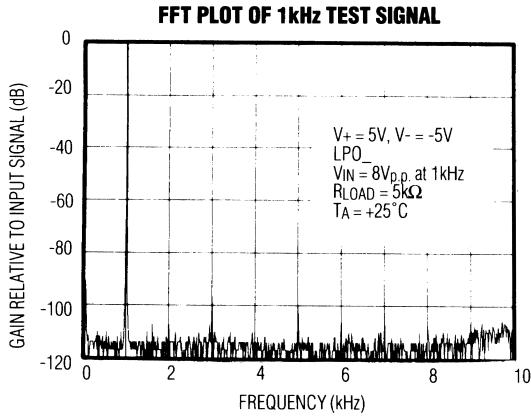

4th- and 8th-Order Continuous-Time Active Filters

Typical Operating Characteristics—MAX275

MAX274/MAX275/Software/EV Kit

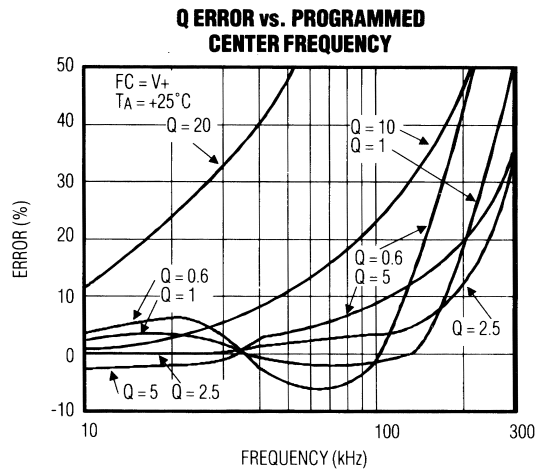
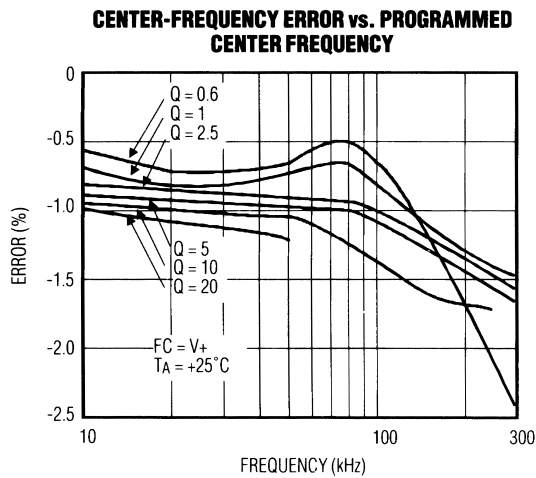
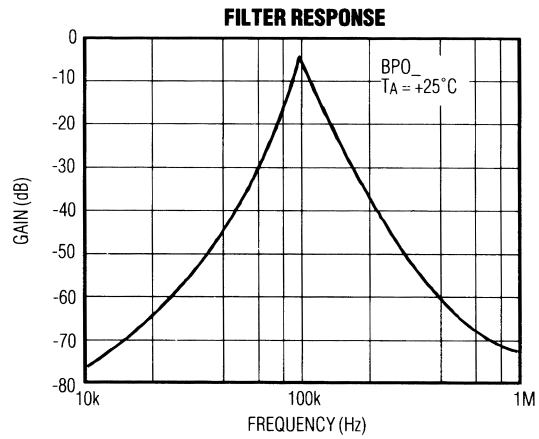
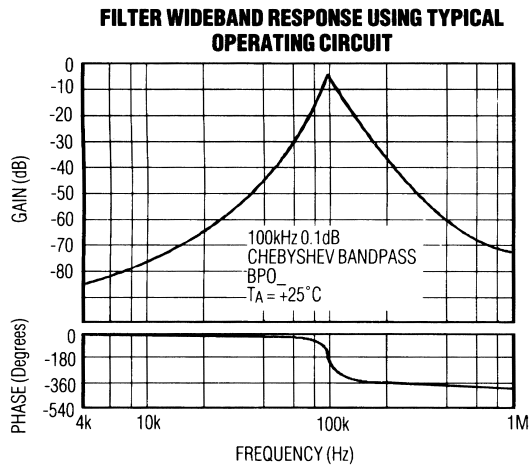

4th- and 8th-Order Continuous-Time Active Filters

Typical Operating Characteristics—MAX275 (continued)

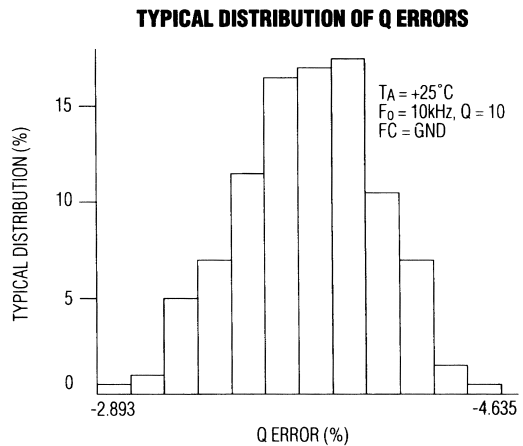
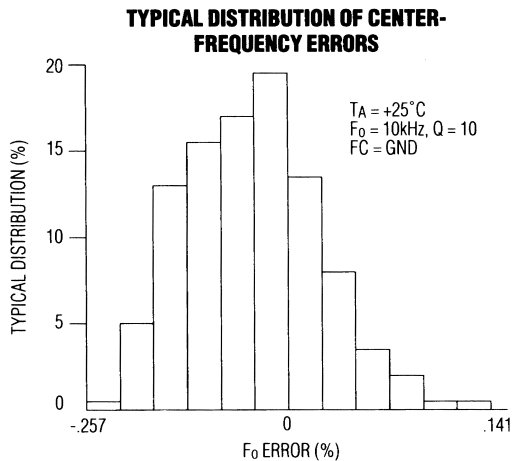
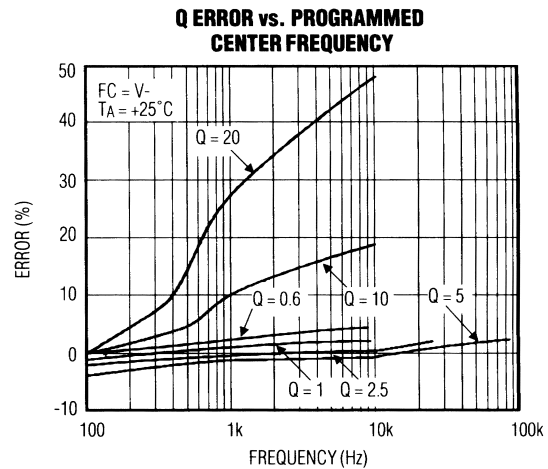
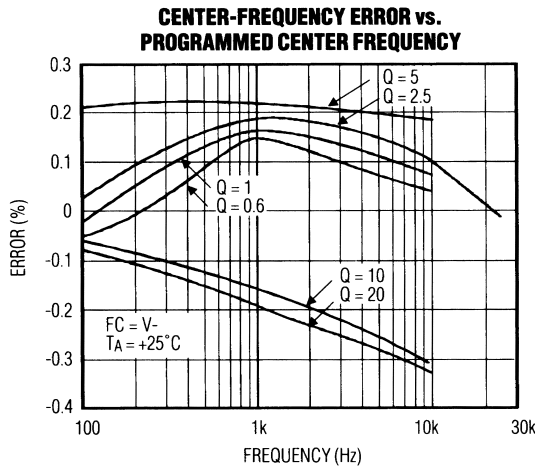
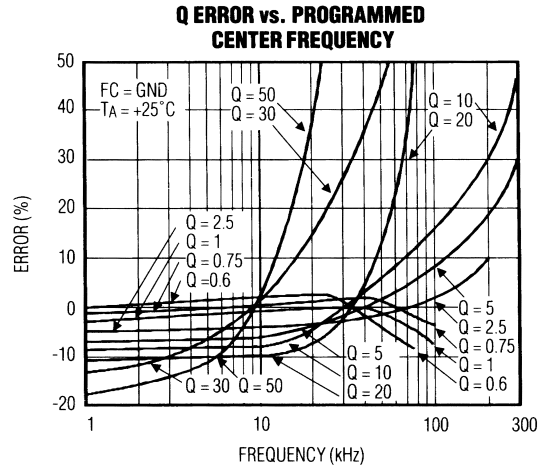
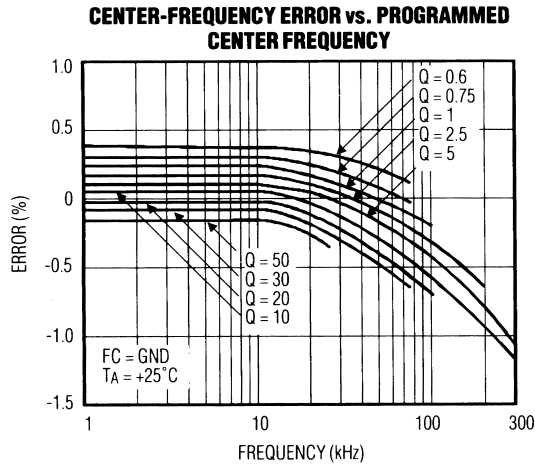

4th- and 8th-Order Continuous-Time Active Filters

Typical Operating Characteristics—MAX275 (continued)

FFT PLOT OF 1kHz TEST SIGNAL

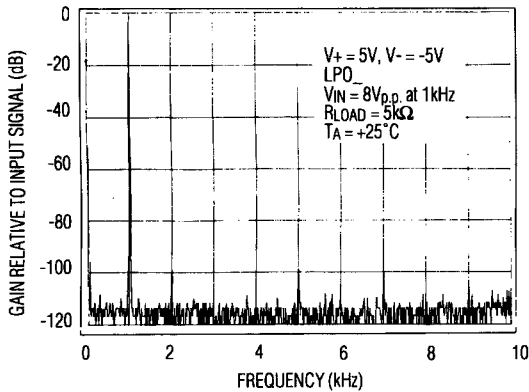

FFT PLOT OF 10kHz TEST SIGNAL

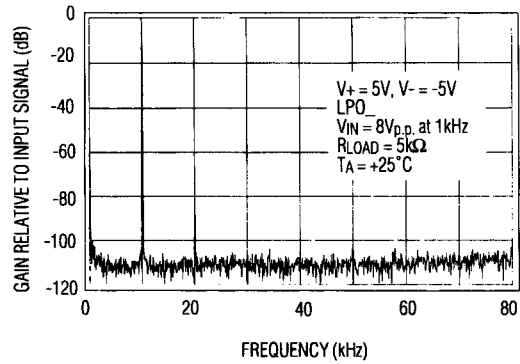

SUPPLY CURRENT vs. SUPPLY VOLTAGE

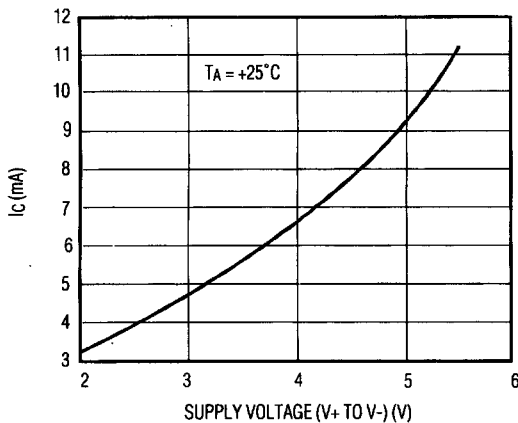

SIGNAL-TO-NOISE + DISTORTION (SINAD) vs. OUTPUT SWING

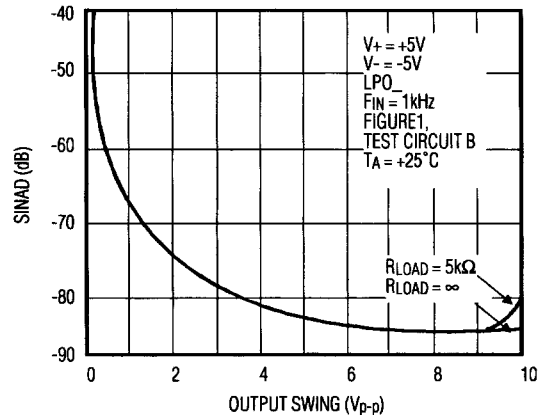

NOISE-SPECTRAL DENSITY vs. FREQUENCY

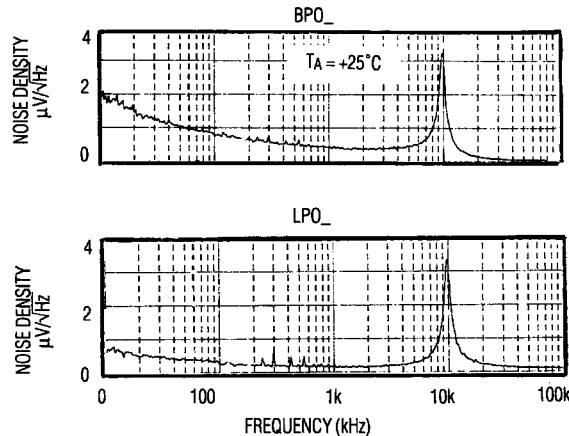

4th- and 8th-Order Continuous-Time Active Filters

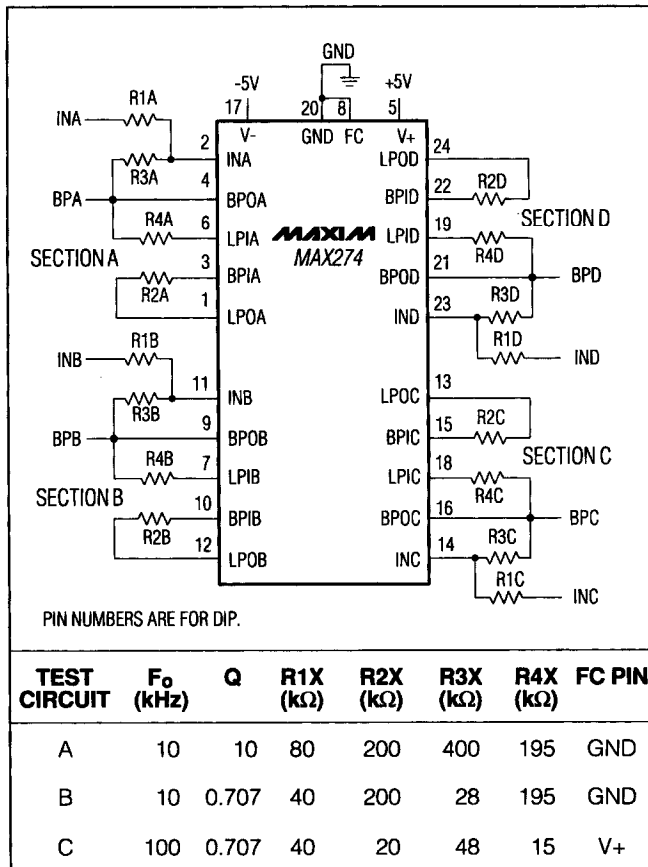

Figure 1a. MAX274 Connection Diagram and Test Circuit

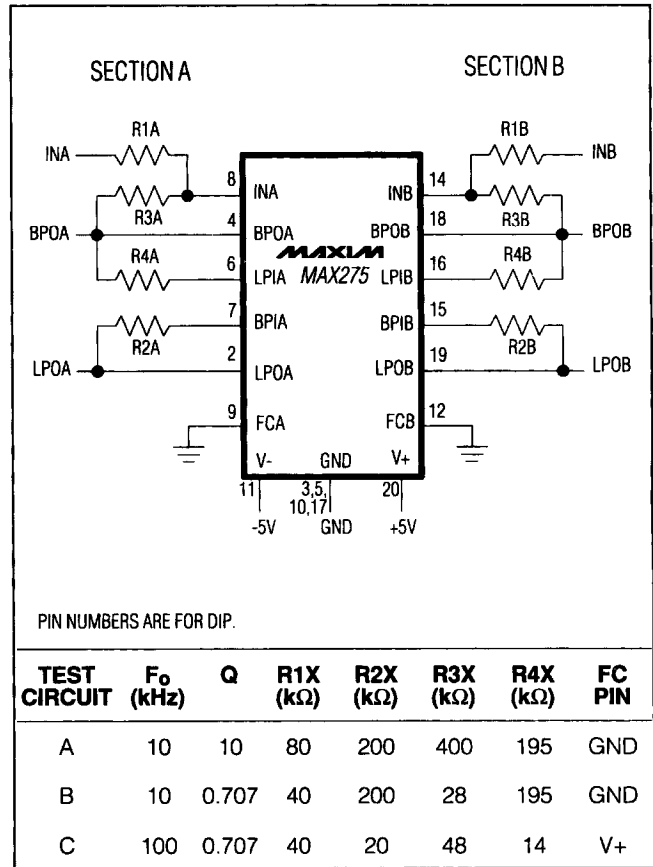

Figure 1b. MAX275 Connection Diagram and Test Circuit

Detailed Description

The MAX274 contains four identical 2nd-order filter sections while the MAX275 contains two sections. Figure 2 shows the state-variable topography employed in each filter section. This topography allows simultaneous low-pass and bandpass functions at separate outputs.

The MAX274/MAX275 employ a four-amplifier design, chosen for its relative insensitivity to parasitic capacitances and high bandwidth. The built-in capacitors and amplifiers, together with external resistors, form cascaded integrators with feedback to provide simultaneous lowpass and bandpass filtered outputs. To maximize bandwidth, the highpass (HP) node is not accessible. A 5kΩ resistor is connected in series with the input of the last stage amplifier to isolate the integration capacitor from external parasitic capacitances that could alter the filter's pole accuracy.

Although a notch output pin is not available, a notch can be created at the pole frequency by summing the input

and bandpass output. See Creating a Notch Output Section

Filter Design Procedure

Figure 3 outlines the overall filter design procedure. Maxim's Filter Design Software is highly recommended. This software automatically calculates filter order, poles, and Qs based on the required filter shape, so no manual calculations are necessary. Menu-driven commands and on-screen filter response graphs take the user through the complete design process, including the selection of resistor values for implementing a filter with the MAX274/MAX275. See *Maxim Filter Design Software* section.

If designing without the filter software, see the filter design references listed at the end of this data sheet. These references provide numerical tables and equations needed to translate a desired filter response into order, poles, and Q. Once these three parameters have been calculated, see the next section, *Translating F_o/Q Pairs into MAX274/MAX275 Hardware (Resistor Selection)*.

4th- and 8th-Order Continuous-Time Active Filters

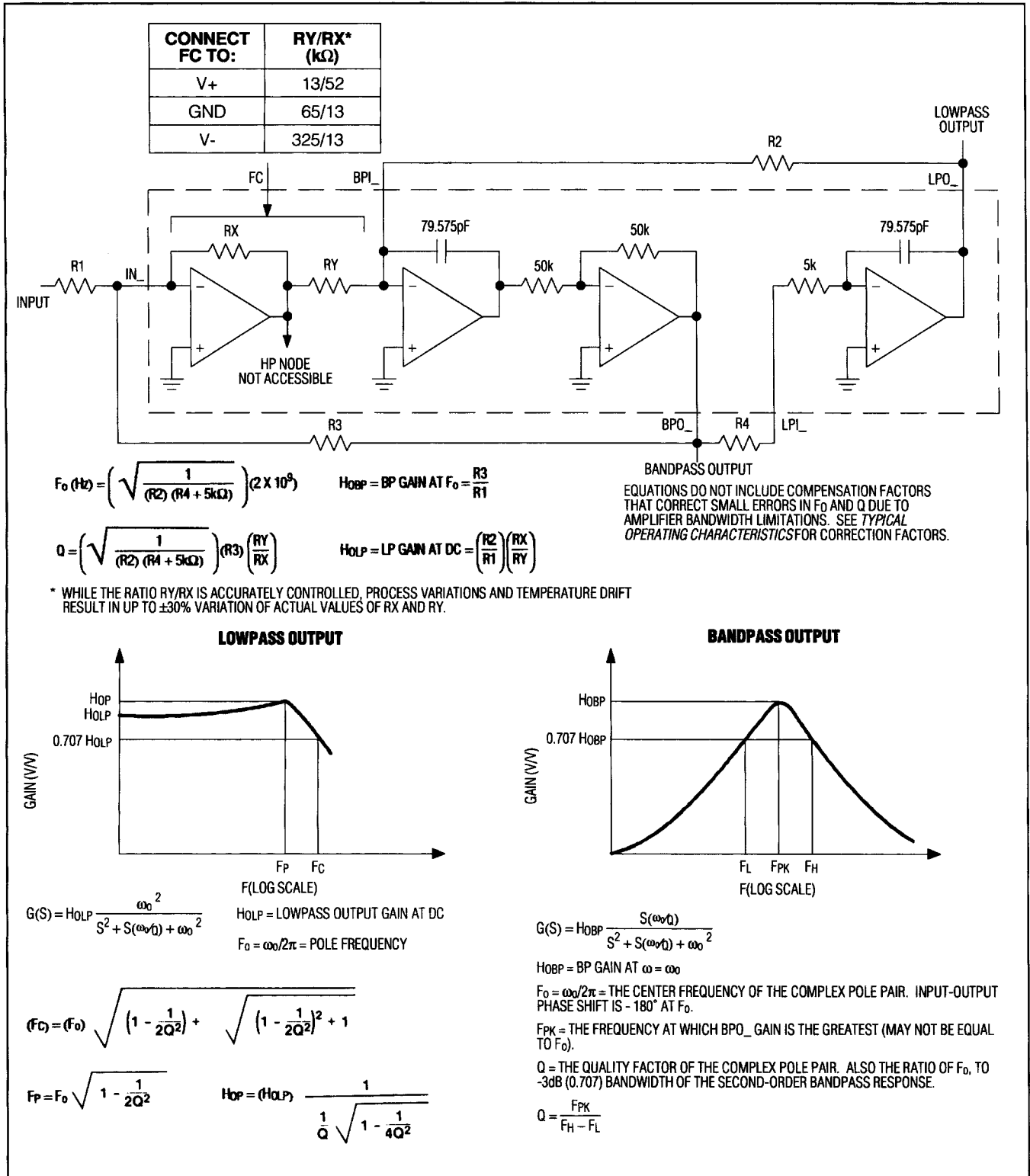

Figure 2. Single 2nd-Order Filter Section

4th- and 8th-Order Continuous-Time Active Filters

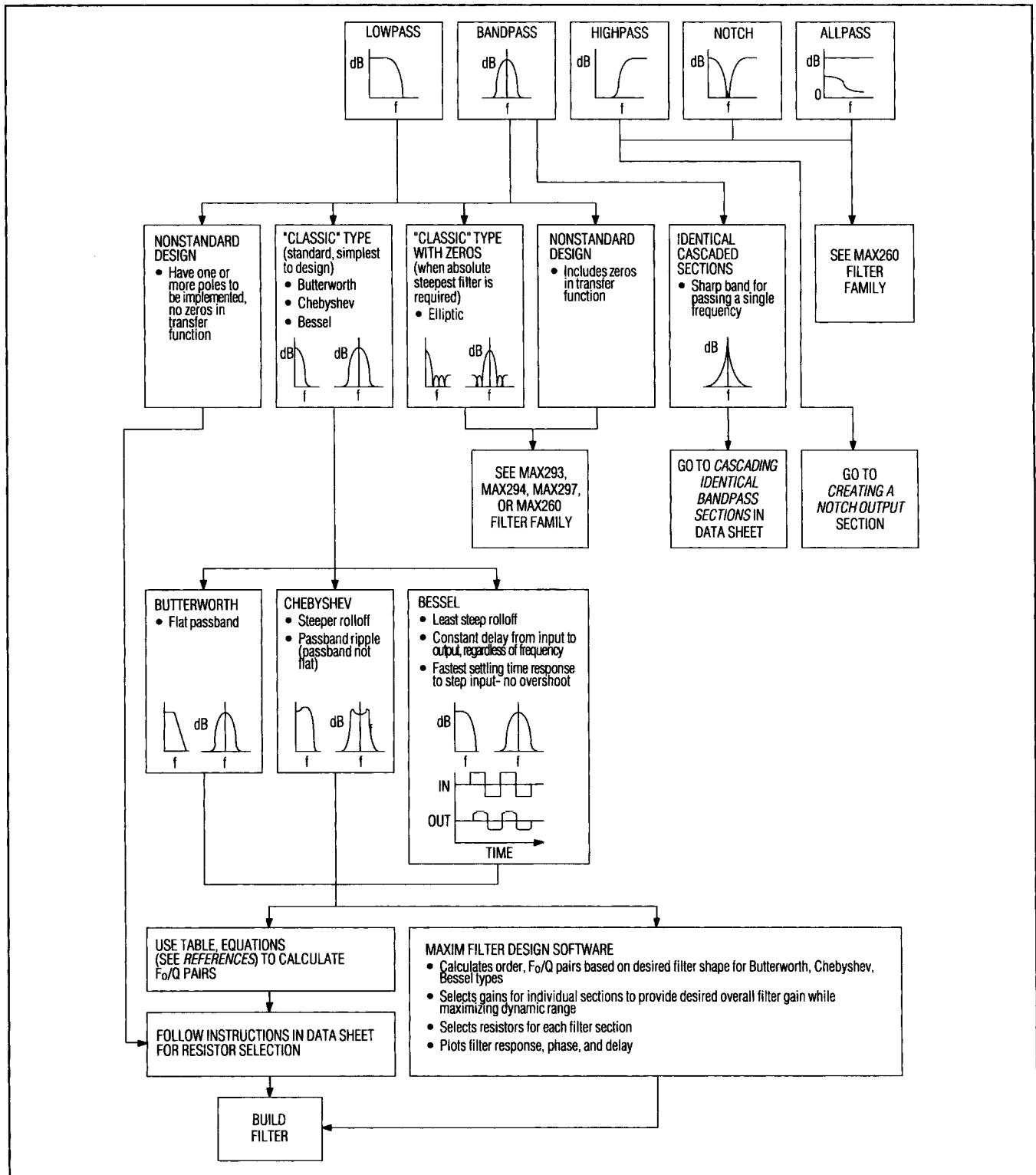

Figure 3. General Filter Design Flowchart

4th- and 8th-Order Continuous-Time Active Filters

Translating Calculated F_o/Q Pairs into MAX274/MAX275 Hardware (Resistor Selection)

If the filter design procedure has been completed as outlined in Figure 3, with the exception of external resistor selection, follow these steps:

1. Check all F_o/Q pairs for realizability. The MAX274/MAX275 have limits on which F_o/Q values can be implemented. These limits are bound by finite amplifier gain-bandwidth and amplifier load drive capability (which limit the highest frequency F_o /highest Qs) as well as amplifier noise pickup and susceptibility to errors caused by stray capacitance (which sets a low-frequency limit on the poles). Refer to Figure 4 to be sure each F_o/Q pair is within the "realizable" portion of the graph. If filter Qs are too high, reduce them by increasing the filter order (that is, increase the number of poles in the overall filter).

High-frequency F_o s (up to 400kHz) and high Qs outside of Figure 4's limits are also realizable, but F_o and Q will deviate significantly from the ideal. Adjust resistor values by prototyping.

To implement F_o s less than 100Hz, see *High-Value Resistor Transformation* section.

2. Calculate resistor values for each section (F_o/Q pair). Calculate resistor values using graphs and equations in steps A through D of this section. Begin by estimating required values according to the graphs; then use the given equations to derive a precise value.

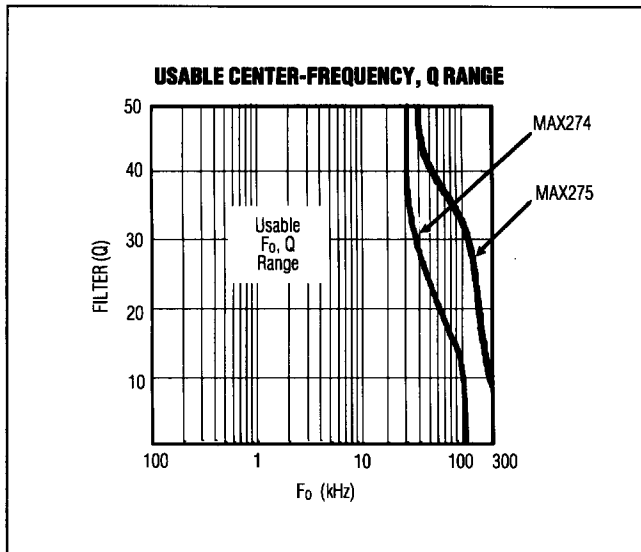

Figure 4. Usable F_o , Q Range. See *Translating F_o/Q Pairs into Hardware (Resistor Selection)*.

Resistor values should not exceed $4M\Omega$ because parasitic capacitances shunting such high values cause excessive F_o/Q errors. Values lower than $5k\Omega$ for $R2$ and $R3$ are not recommended due to limited amplifier output drive capability. For cases where larger values are unavoidable (as in low-frequency sections) refer to the *High-Value Resistor Transformation* section.

The Frequency Control (FC) pin is connected to $V+$, GND, or $V-$ and scales $R3$ and $R1$ to accommodate a wide range of gains and Q values. Different FC settings may be chosen for each section. Refer to the *FC Pin Connection* section.

The steps for calculating resistor values are given below.

STEP A. CALCULATE $R2$.

$$R2 = \frac{(2 \times 10^9)}{F_o}$$

RESISTOR $R2$ vs. DESIRED CENTER FREQUENCY

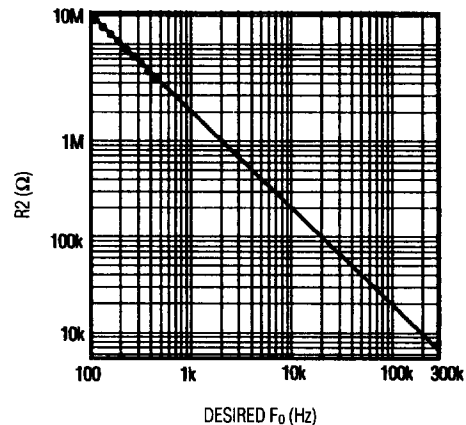

... USE RESISTOR "T-NETWORK" TO REDUCE VALUE (SEE HIGH-VALUE RESISTOR TRANSFORMATION SECTION)

Resistors $R2$ and $R4$ set the center frequency.

STEP B. CALCULATE $R4$.

$$R4 = R2 - 5k\Omega$$

$R4$ may be less than $5k\Omega$ because an internal series $5k\Omega$ resistor limits BPO_ loading

4th- and 8th-Order Continuous-Time Active Filters

STEP C. CALCULATE R3.

R3 sets the Q for the section. R3 values are plotted assuming Q = 1; since R3 is proportional to Q, multiply the graph's value by the desired Q.

Given Q, three choices exist for R3, depending on the FC setting. Choose a setting that provides a reasonable resistor value ($5k\Omega < R3 < 4M\Omega$). $R3 > 4M\Omega$ may be used if unavoidable – refer to the *High-Value Resistor Transformation* section for an explanation of resistor "Ts."

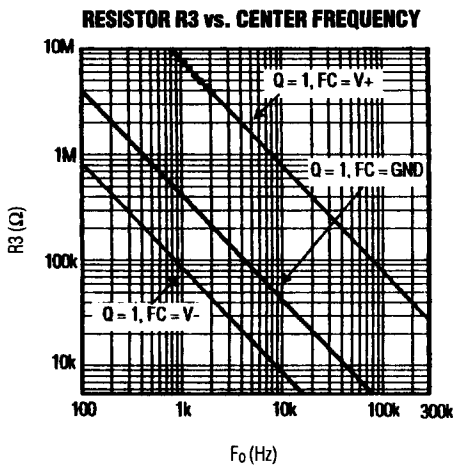

... USE RESISTOR "T-NETWORK" TO REDUCE VALUE
(SEE HIGH-VALUE RESISTOR TRANSFORMATION SECTION)

Scale R3 to desired Q

$$R3 = \frac{(Q) (2 \times 10^9)}{F_o} \times \left(\frac{RX}{RY} \right)$$

CONNECT FC TO:	RX/RY
V+	4/1
GND	1/5
V-	1/25

STEP D. CALCULATE R1.

R1 sets the gain. If individual section gains have not yet been calculated, refer to *Cascaded Filter Gain Optimization, Ordering of Sections*.

R1 is inversely proportional to LP gain. R1 values for gains of 1 and 10 are plotted; scale R1 according to desired gain.

Lowpass Filters:

The FC pin setting was chosen in Step C (or from previous section calculations).

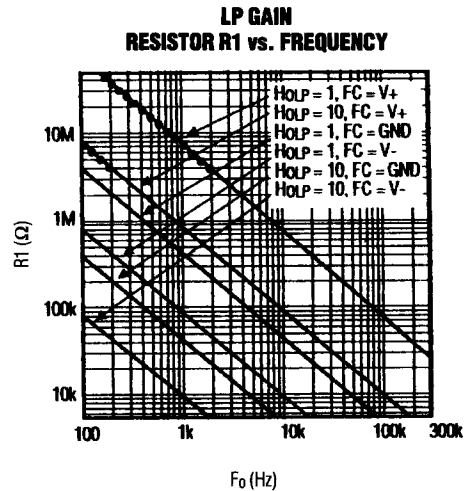

... USE RESISTOR "T-NETWORK" TO REDUCE VALUE
(SEE HIGH-VALUE RESISTOR TRANSFORMATION SECTION)

$$R1 = \frac{(2) (10^9)}{(F_o) (H_{OLP})} \times \left(\frac{RX}{RY} \right)$$

CONNECT FC TO:	RX/RY
V+	4/1
GND	1/5
V-	1/25

where H_{OLP} is the gain at LPO_ at DC.

4th- and 8th-Order Continuous-Time Active Filters

Bandpass Filters:

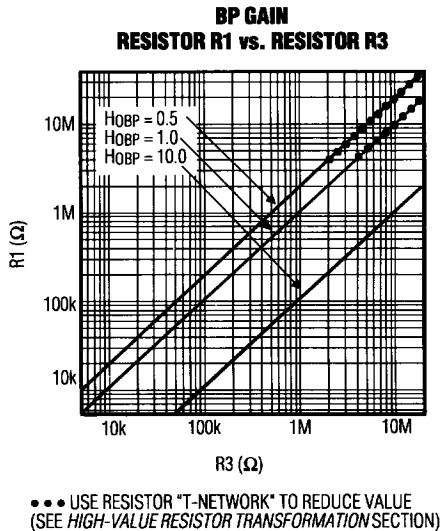

$$R1 = \frac{R3}{H_{OBP}}$$

where H_{OBP} is the gain at BPO_{-} at F_o .

3. Recalculate resistor values to compensate for filter amplifier bandwidth errors. Some of the *Typical Operating Characteristics* graphs show deviations in F_o and Q compared with expected values, due to gain rolloff of the internal amplifiers. If desired, correct these deviations by recalculating values $R1$ - $R4$.

4. Build a filter prototype. Build and test all filter designs! Refer to the Prototyping, PC-Board Layout section of this data sheet.

For applications that require high accuracy (for example, those with filter sections containing Q_s greater than 10) or those that use a ground plane, a final prototype tuning procedure is recommended. Build a prototype filter; then adjust resistor values of each section until desired accuracy is achieved.

High-Value Resistor Transformation

High-value resistors (greater than $4M\Omega$) used in the MAX274/MAX275 filter circuit introduce excessive F_o and Q errors. To reduce the impedance of these feedback paths while maintaining equivalent feedback current, use the resistor "T" method shown in Figure 5.

F_o s less than 100Hz can be realized using T-networks. T-networks provide the equivalent of large resistor values for $R2$, $R3$, and $R4$, necessary for low-frequency filters; however, T-networks reduce dynamic range by attenuating the input signal level. Note that parasitic capacitances across these high resistor values affect the filter response at high frequencies. For best results, build a prototype and check its performance thoroughly.

Odd Number of Poles

For lowpass designs containing an odd number of poles, add an RC lowpass filter after the final filter section. The value of RC should be:

$$RC = 1/2\pi F_o$$

where F_o is the desired real pole frequency. If required, buffer the RC with an op amp.

In many cases it may be advantageous to simply increase the filter order by 1, and implement it with an additional 2nd-order section.

FC Pin Connection

Connect FC to GND for all applications, except where resistor values fall below $5k\Omega$ (at high F_o s, low Q_s). In these cases connect FC to $V+$. For low F_o s and high Q_s , connect FC to $V-$ to keep the value of $R1$ and $R3$ below $4M\Omega$.

F_o and Q errors are significantly higher when FC is connected to $V+$ or $V-$ (see Typical Operating Characteristics). Adjusting resistor values compensates for these errors, since the errors are repeatable from part to part. Note that noise increases threefold when FC is connected to $V+$.

Cascading Identical Sections for Simplest Bandpass

If designing a bandpass filter where a single frequency (or a very narrow band of frequencies) must be passed, several 2nd-order sections with identical F_o s and Q_s may be cascaded. The resulting Q (selectivity) of the filter is a function of the individual sections' Q_s and the number of sections cascaded:

$$Q_t = \frac{Q}{\sqrt{2^{1/n} - 1}}$$

where Q_t is the overall cascaded filter Q , Q is the Q of each individual section, and N is the number of sections.

4th- and 8th-Order Continuous-Time Active Filters

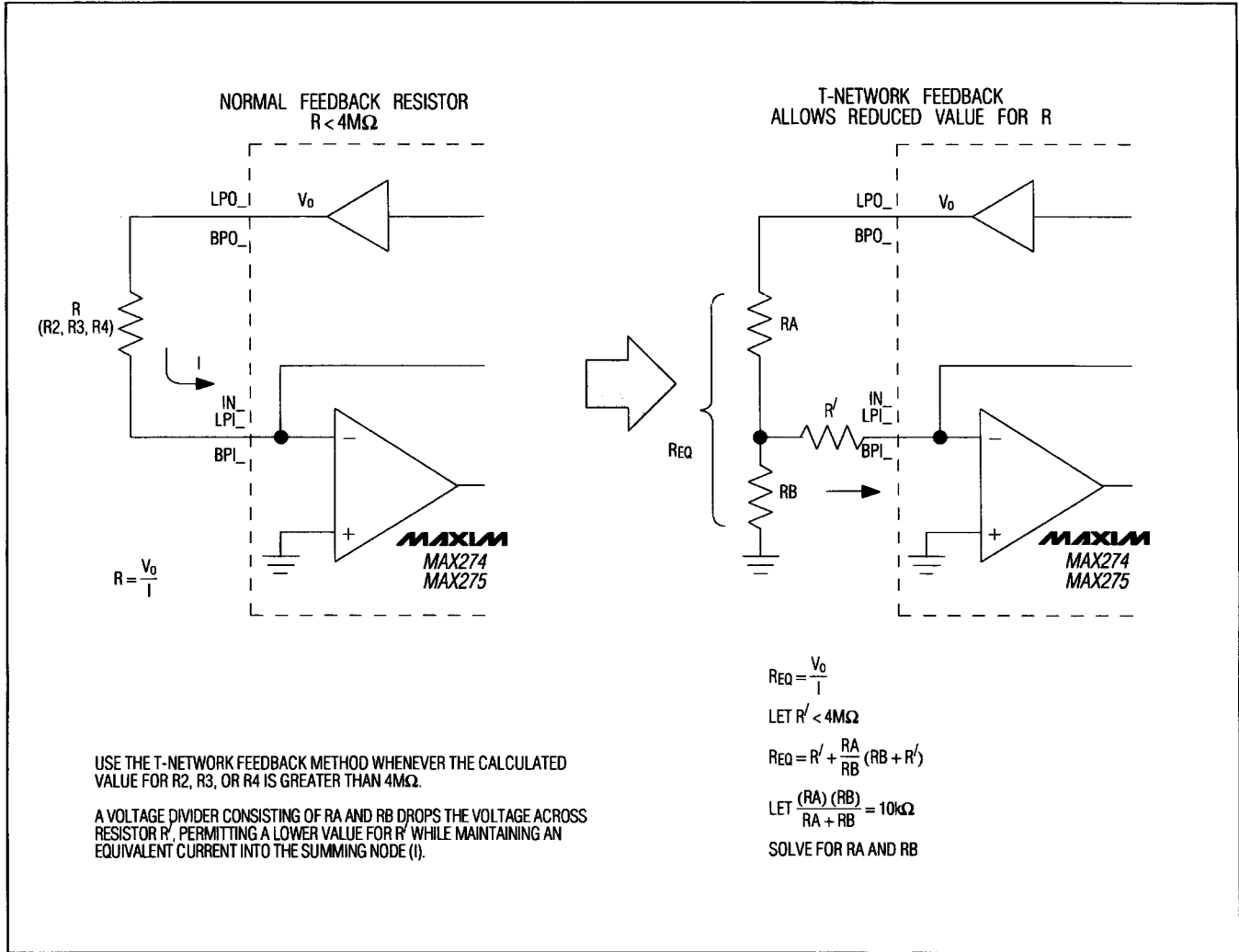

Figure 5. Resistor T-Networks Reduce Resistor Values

4th- and 8th-Order Continuous-Time Active Filters

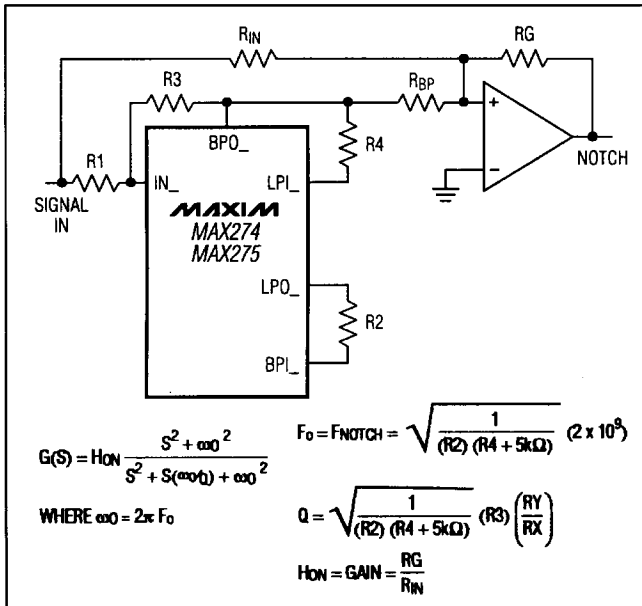

Figure 6a. Creating a Notch Output

Creating a Notch Output

A notch (zero) can be created in the filter response by summing the input signal with BPO_ using an external op amp (Figure 6a). The notch will have the poles and Q characteristics of the 2nd-order section, as well as a zero at the pole frequency (transfer function given in Figure 6a). H_{ON} (BP gain at F_0) must be accurately set to unity so the input signal summed with BPO_ cancels precisely at the pole frequency. The notch's maximum attenuation is therefore a function of the accuracy of R1, R3, RIN, and RBP.

A notch can be used to create a null within the passband of a lowpass filter to reject specific frequencies (see Applications section).

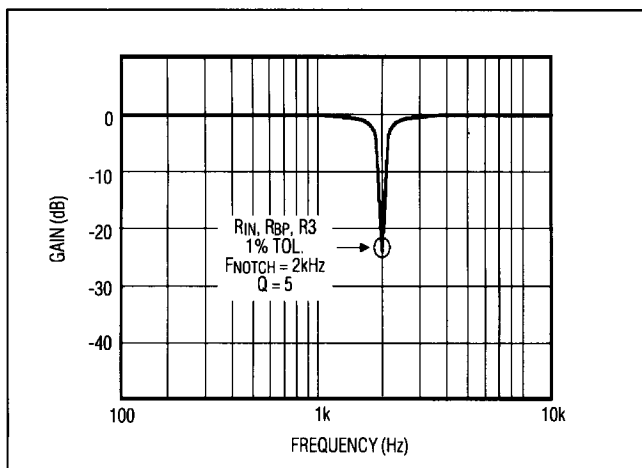

Figure 6b. Notch Response

Cascaded Filter Gain Optimization, Ordering of Sections

Gains across the individual sections in a filter may be set an infinite number of ways, as long as the total gain from filter input to output is correct. Often, gains cannot be equally divided among sections, since different F_0 s and Qs create gain peaks and valleys at different frequencies for each section.

The goal in choosing gains is to prevent section outputs from swinging beyond the $\pm 3.25V$ limit (using $\pm 5V$ supplies) while the full input signal is applied. On the other hand, if section gains are set too low and only a small proportion of output range is used, the noise factor increases. An optimal gain distribution between sections allows each section to swing as close to $\pm 3.25V$ as possible in a wide range of frequencies.

Check the unused output (BPO_ or LPO_), and the internal HP node for overvoltage, since clipping at any node will cause distortion at the outputs. The HP node is not available for probing (Figure 2); however, its gain may approach R_X / R_1 . Low R1 values and connecting FC to V+ (which sets R_X as high as 64k Ω) may cause this node to clip.

Maxim's Filter Design Software allows optimum gain by plotting output gains of each successive cascaded filter section, including the internal node. Gains may be adjusted manually and sections reordered for the best overall dynamic range.

To optimize gain without the help of software, begin by ordering the sections from lowest Q to highest Q. Divide gains equally between sections, setting each section gain to:

$$H_0 = A^{(1/N)}$$

where A = overall filter gain

$H_0 = H_{ON}$ for bandpass designs (gain at F_0)

$H_0 = H_{OLP}$ for lowpass designs (gain at DC)

N = total number of sections

This approach offers a good first-pass solution to clipping problems in the high Q sections by keeping gains low in the first (low Q) sections. The gains may then be adjusted in hardware to maximize overall dynamic range.

4th- and 8th-Order Continuous-Time Active Filters

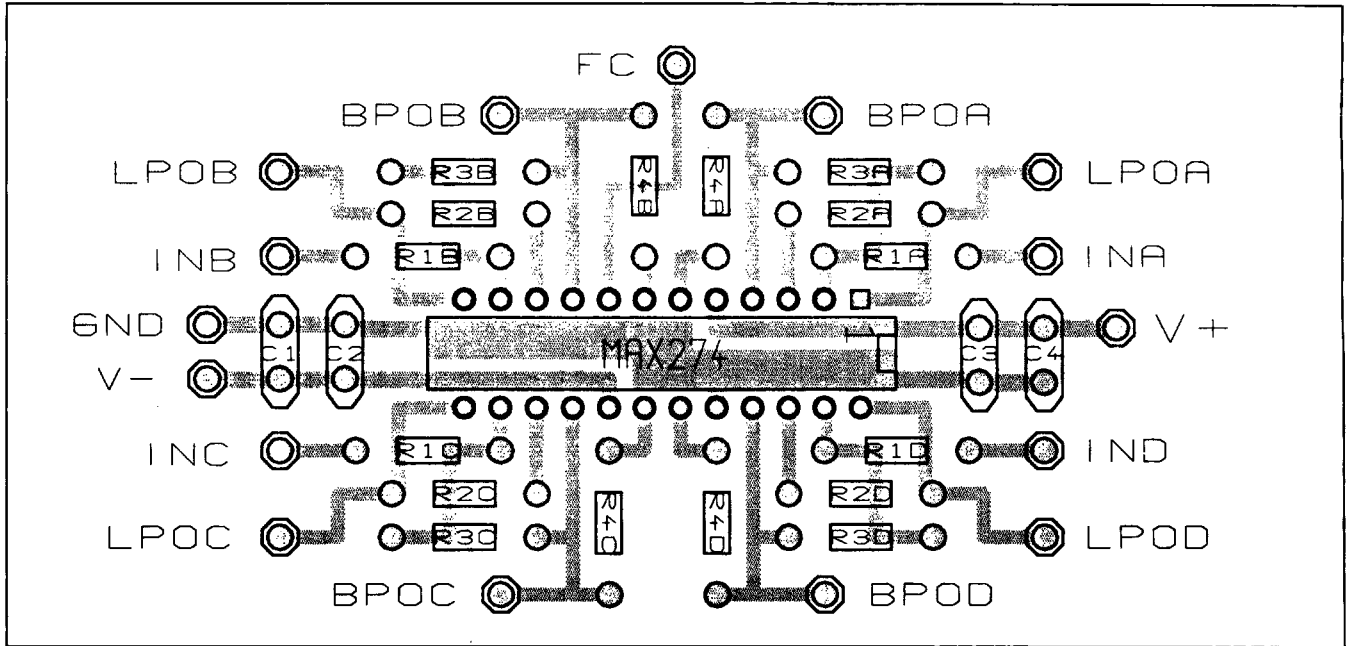

Figure 7a. MAX274 Suggested PC-Board Layout for DIP

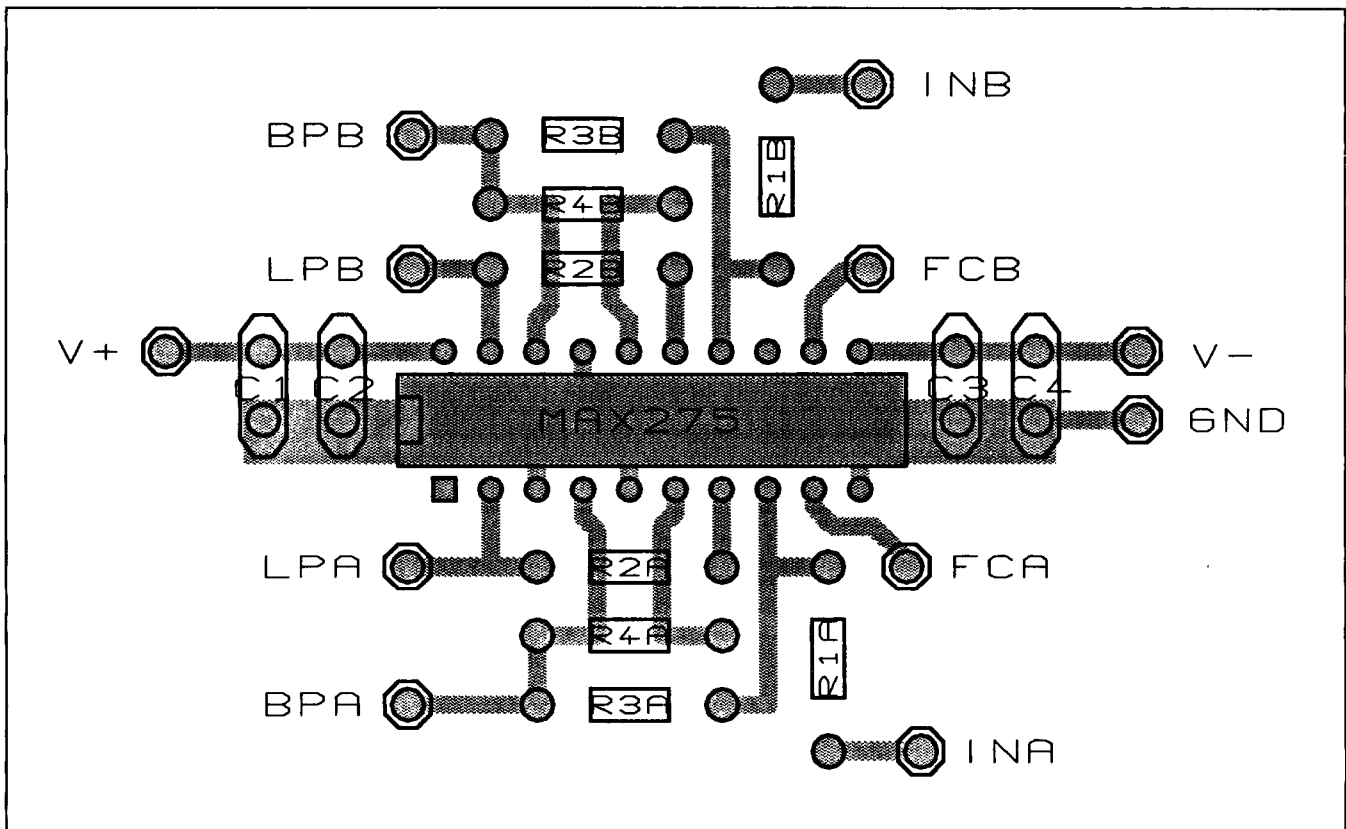

Figure 7b. MAX275 Suggested PC-Board Layout for DIP

4th- and 8th-Order Continuous-Time Active Filters

Resistors

Aside from accuracy, the most important criterion for resistor selection is parasitic capacitance across the resistor. Typical capacitance should be less than 1pF. Precision wire-wound resistors exhibit several picofarads, as well as unacceptable inductance – DO NOT USE THESE. Capacitance effectively reduces the resistance at high frequencies (especially when using high-value resistors), and causes phase shifts in feedback loops. Do not mount resistors in sockets. Socket capacitance appearing across resistors is often several picofarads, and will cause significant errors in F_o and Q . Metal-film resistors minimize noise better than carbon types.

Prototyping, PC-Board Layout

For highest accuracy filters, build the filter prototype on a PC board with a layout as similar as possible to the final production circuit. If a ground plane will be used in production, build prototype filters on a copper board. Do not use push-in type breadboards for prototyping – pin-to-pin capacitance is too high. For faster prototyping, the MAX274 evaluation kit includes a PC-board circuit to test designs.

Layout-sensitive errors, though repeatable from part to part, vary according to resistor placement, trace routing, and ground-plane layout. For highest accuracy, use the recommended layout provided in Figures 7a and 7b. Keep all traces, especially LPI_- and BPI_- , as short as possible. LPI_- and BPI_- are particularly sensitive to ground capacitance, and may cause errors in Q . If a ground plane is used, tune the prototype filter by adjusting resistor values to cancel errors caused by ground capacitance.

Prevent capacitive coupling between pins. Coupling between BPI_- and BPO_- can cause F_o errors; capacitance across resistors connecting IN and BPO_- ($R3$), BPI_- and LPO_- ($R2$), and BPO_- and LPI_- ($R4$) cause F_o and Q errors. Minimize these errors with "tight" (shortest trace) layout practices.

Measuring F_o and Q

For multiple-order filters, measure each section individually, before cascading, to verify correct F_o and Q . For best results, measure BPO_- with a spectrum analyzer. F_o is the frequency at which the input and BPO_- are 180° out of phase. Q is the ratio of F_{PK} to BPO_- 's - 3dB bandwidth (Figure 2), where F_{PK} is the frequency at which BPO_- gain is the greatest (which may not be equal to F_o).

Filter F_o and Q Accuracy

F_o sensitivity to external resistor tolerance is 1:1 – for example, use of 1% tolerant resistors for $R2$ and $R4$ adds $\pm 1\%$ error to F_o (which should be added to the $\pm 1\%$ tolerance of the MAX274/MAX275, guaranteed over temperature). Q errors are of greater magnitude, since they are a function of the internal resistor divider (controlled by the FC pin) and also involve $R3$. Typical Q error distributions are given in the *Typical Operating Characteristics*; additional Q errors associated with resistor tolerances are a function of $R2$, $R3$, and $R4$, and must be calculated according to the values used.

DC Offset Removal

Figures 8a and 8b show methods for removing the DC offset voltage at LPO_- . The first method shows adjustable DC nulling signals injected into either BPI_- or the filter input. R_{TRIM} must be adjusted until DC offset is nulled at the LPO_- (Figure 8a). Figure 8b shows a trimless solution for lowpass filters that removes DC offset by AC coupling the LPO_- output, while allowing a DC path through R from the input. At DC and low frequencies, the output is equal to the prefiltered signal input (across R); at higher frequencies, C conducts and the output equals the signal at LPO_- . The external RC pole should be set at least one frequency decade lower than the overall filter F_o . A low offset amplifier can buffer the output signal, if desired. For bandpass filters, a simple buffered RC highpass filter at the output removes DC offset.

Noise and Distortion

Noise-spectral density is shown in the *Typical Operating Characteristics*. The noise frequency distribution is shaped by the filter gain and response (higher Q section will have a proportionally higher noise peak around the pole frequency), as well as by amplifier $1/f$ noise. With FC set to $V+$, noise is 3 times greater than if set to GND or $V-$; therefore, avoid this setting for noise-sensitive applications. The noise density graphs from the *Typical Operating Characteristics* can be scaled to any gain or Q for an accurate noise estimation.

The MAX274/MAX275 can drive 5k Ω loads to typically within ± 500 mV of the supply rails with negligible distortion. The outputs can drive up to 100pF; however, filters with high F_o s and Q s will undergo some phase shift (1° at 100kHz driving 130pF, $F_o = 100$ kHz, $Q = 10$ section).

4th- and 8th-Order Continuous-Time Active Filters

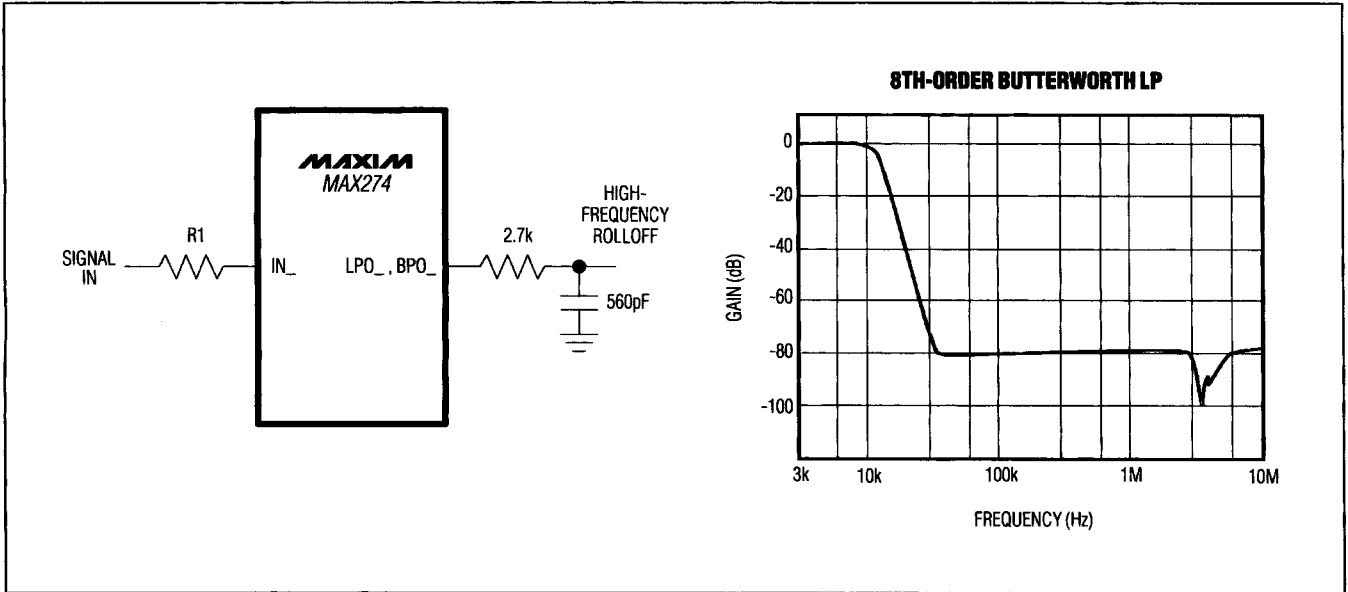

Figure 10. External RC Lowpass for High-Frequency Rolloff

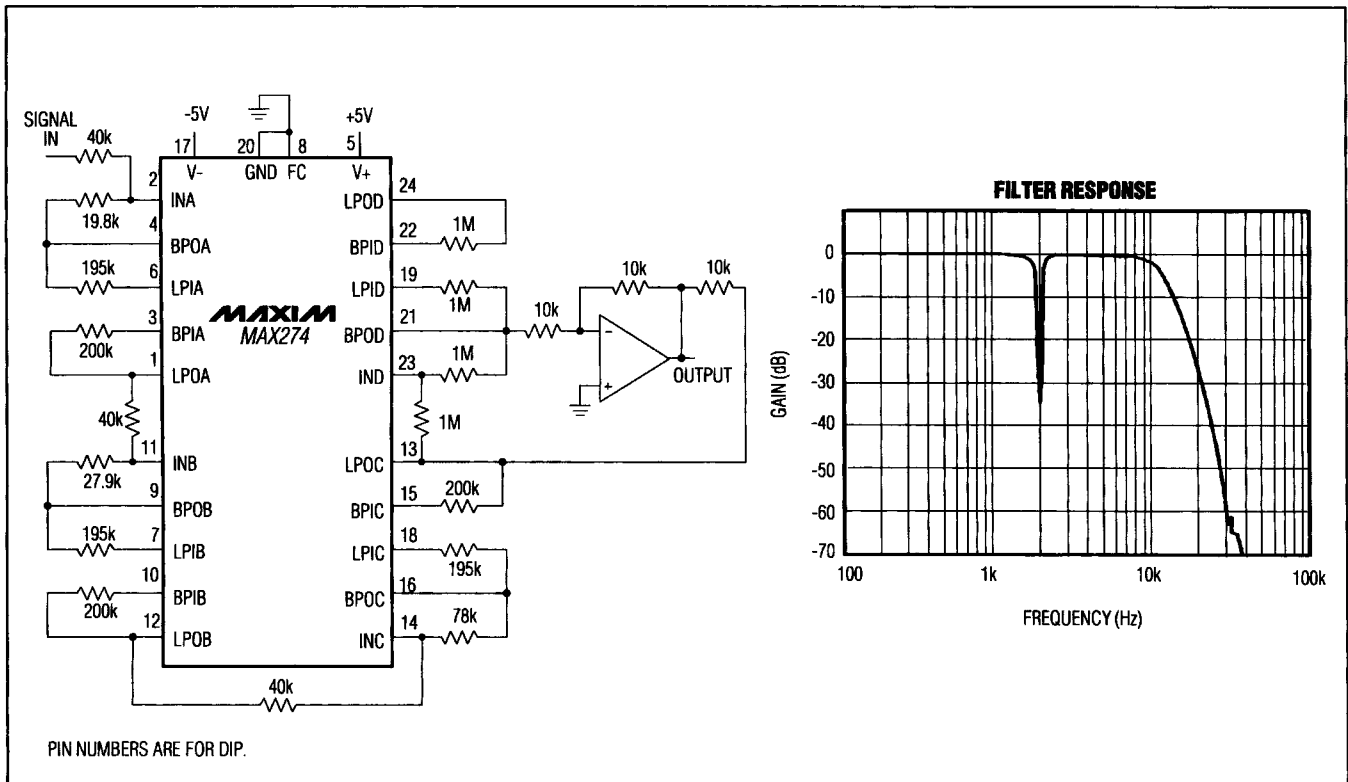

Figure 11. 10kHz 6th-Order Butterworth Lowpass Filter with 2kHz Notch (MAX274)

4th- and 8th-Order Continuous-Time Active Filters

Applications (continued)

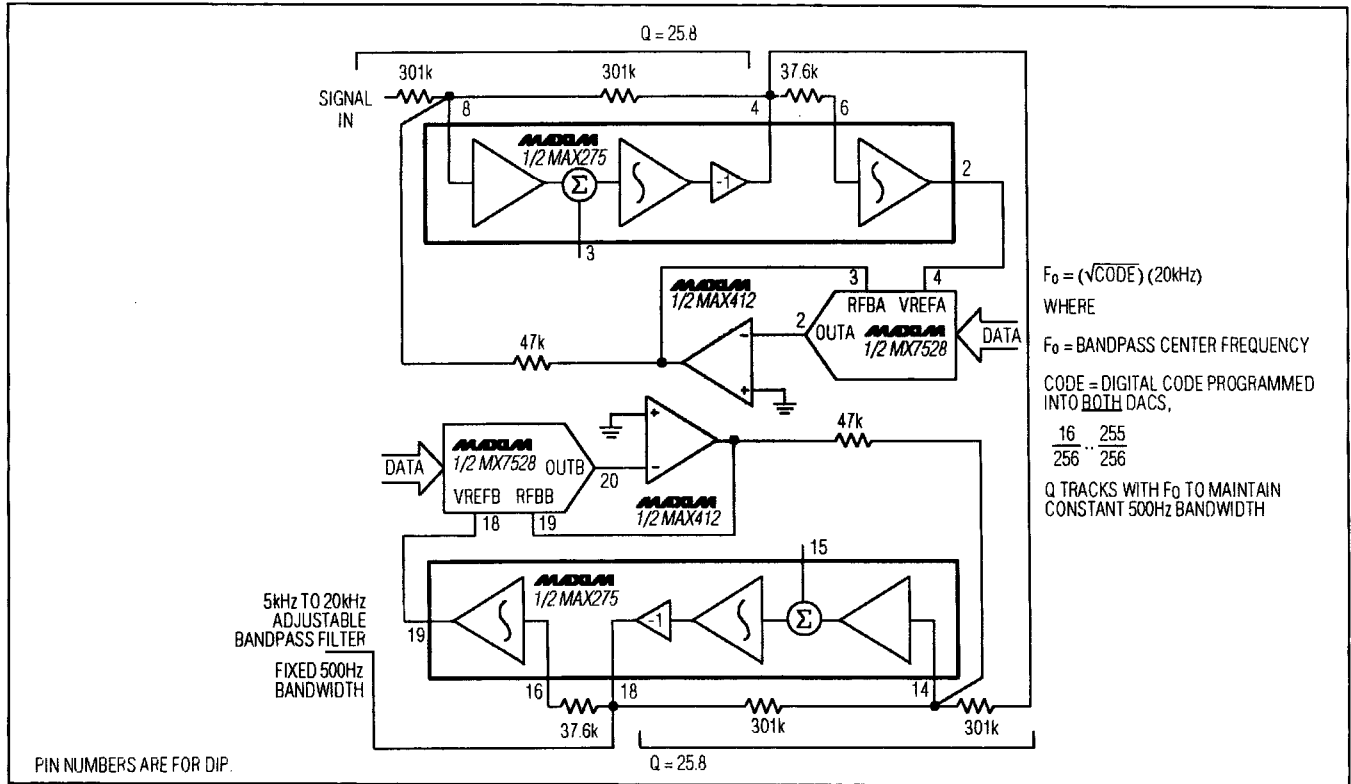
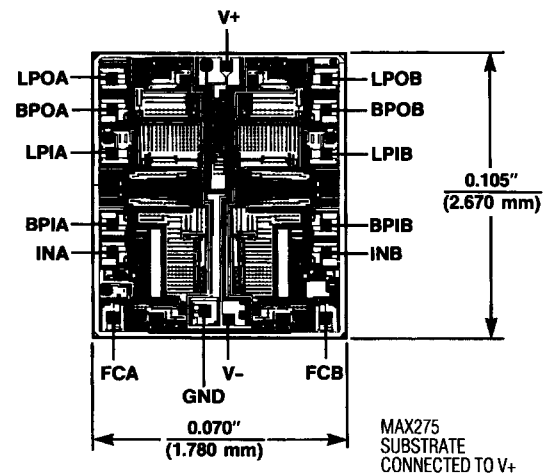
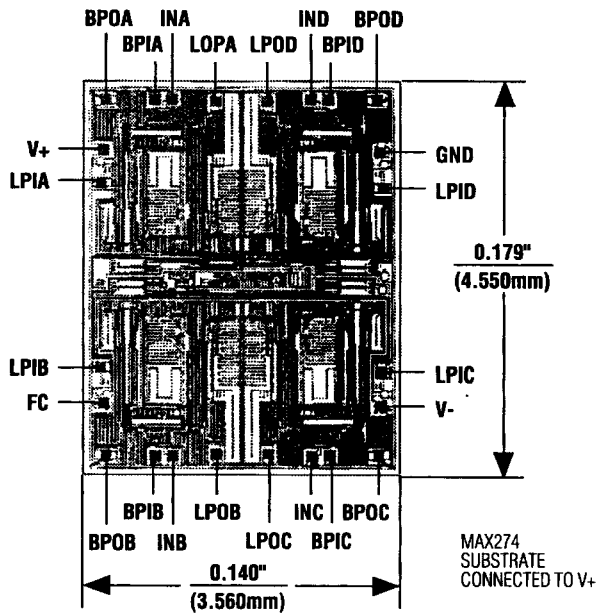

Figure 12. Programmable Bandpass Filter (MAX275)

Chip Topographies



4th- and 8th-Order Continuous-Time Active Filters

Ordering Information (continued)

PART	TEMP. RANGE	PIN-PACKAGE
MAX274AENG	-40°C to +85°C	24 Narrow Plastic DIP
MAX274BENG	-40°C to +85°C	24 Narrow Plastic DIP
MAX274AEWI	-40°C to +85°C	28 Wide SO
MAX274BEWI	-40°C to +85°C	28 Wide SO
MAX274AMRG	-55°C to +125°C	24 CERDIP**
MAX274BMRG	-55°C to +125°C	24 CERDIP**
MAX274EV KIT-DIP	0°C to +70°C	Plastic DIP – Through Hole
MAX274_SOFT	—	MAX274/MAX275 Design Software
MAX275ACPP	0°C to +70°C	20 Plastic DIP
MAX275BCPP	0°C to +70°C	20 Plastic DIP
MAX275ACWP	0°C to +70°C	20 Wide SO
MAX275BCWP	0°C to +70°C	20 Wide SO
MAX275BC/D	0°C to +70°C	Dice*
MAX275AEPP	-40°C to +85°C	20 Plastic DIP
MAX275BEPP	-40°C to +85°C	20 Plastic DIP
MAX275AEWP	-40°C to +85°C	20 Wide SO
MAX275BEWP	-40°C to +85°C	20 Wide SO
MAX275AMJP	-55°C to +125°C	20 CERDIP**
MAX275BMJP	-55°C to +125°C	20 CERDIP**
MAX274_SOFT	—	MAX274/MAX275 Design Software

* Contact factory for dice specifications.

** Contact factory for availability and processing to MIL-STD-883.

Typical Operating Circuits (continued)

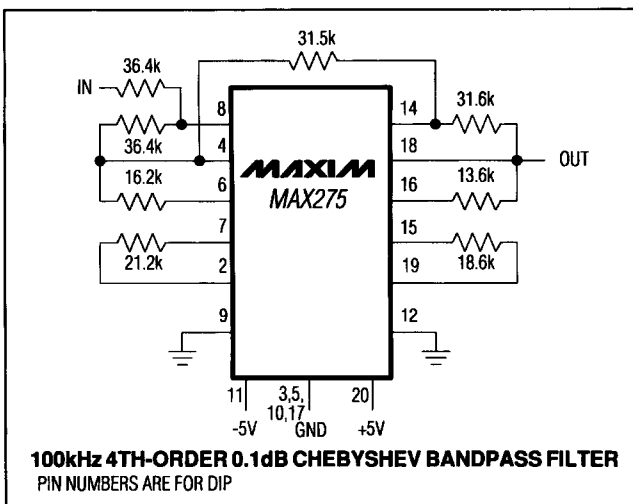

Pin Configurations (continued)

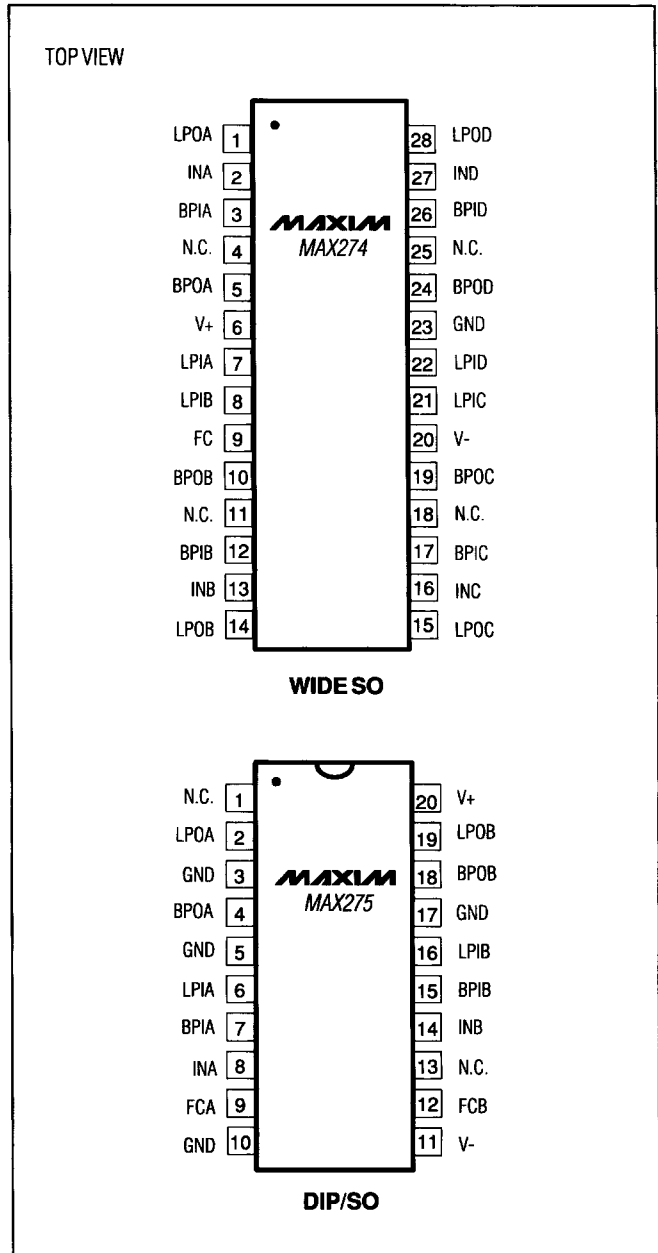

MAX274/MAX275/Software/EV Kit

4th- and 8th-Order Continuous-Time Active Filters

Power Supplies

The MAX274/MAX275 can be operated from a single power supply or dual supplies (Figure 9). V+ and V- pins must be properly bypassed to GND with 4.7 μ F electrolytic (tantalum preferred) and 0.1 μ F ceramic capacitors in parallel. These should be as close as possible to the chip supply pins.

For single-supply applications, GND must be centered between V+ and V- voltages so signals remain in the common-mode range of the internal amplifiers.

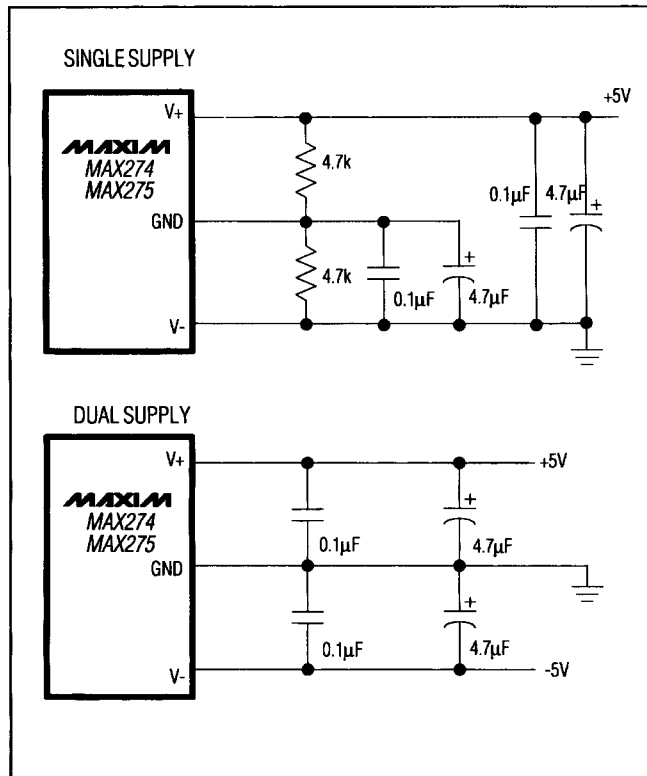

Figure 9. Power-Supply Configurations

Design Software General Description

Maxim's filter software reduces the time required to design a continuous-time lowpass or bandpass filter using the MAX274 or MAX275. Starting from your basic filter requirements, using a "spreadsheet-style" format, the software calculates order, poles and Qs of classic filter types (Butterworth, Chebyshev, or Bessel), and resistor values required to implement the desired filter response.

For hardware prototyping with the MAX274, the MAX274 evaluation kit is recommended, which includes a PC board and a MAX274 IC.

Features

- ◆ Calculates filter order, poles, and Qs from your filter requirements.
- ◆ Plots filter responses – gain, phase, and group delay – for inspection BEFORE you build the filter.
- ◆ Calculates resistor values used to obtain desired filter response using the MAX274 or MAX275.

Ordering Information

PART	DISK TYPE
MAX274SOFT	5¼" Floppy
MAX275SOFT	5¼" Floppy

In the USA and Canada, order directly from Maxim (1-800-998-8800). In other countries, call your local Maxim representative.

Software Operation

NOTE: CHECK FILE "README.DOC" FOR IMPORTANT CHANGES.

Installation

You will need an IBM-compatible PC, DOS version 2.0 or later with a 5¼" floppy disk drive, and one of the following video displays: Hercules graphics, CGA, EGA, VGA, or compatible. Either a hard drive or an additional floppy drive is also required.

To install the program, insert the floppy into your disk drive and type "A: INSTALL" (or B:INSTALL). Follow the instructions on the screen. After installation, type "FILTER" to start the program. Be sure you are in the drive/directory where the software is installed.

Help

After installing the software, print a hard copy of the file FILTER.HLP by entering "TYPE FILTER.HLP > PRN" from DOS. This collection of help screens serves as the instruction manual for operating the software. Individual help screens may be printed while running the software by pressing F1, then following the instructions on the screen.

References

The following references contain information and tables to aid in filter designs:

- Carson, Chen. *Active Filter Design*, Hayden, 1982.
- Tedeschi, Franck. *Active Filter Cookbook*, Tab Books No 1133, 1979.
- Hilburn, Johnson. *Manual of Active Filter Design*, McGraw Hill, 1973.
- German Language:
U. Tietze; Ch. Schenk. *Halbleiter-Schaltungstechnik* Springer-Verlag, Berlin Heidelberg, New York/Tokyo 1991.

4th- and 8th-Order Continuous-Time Active Filters

MAX274/MAX275/Software/EV Kit

EV Kit General Description

The MAX274 Evaluation Kit (EV Kit) shrinks the time required to design and implement a continuous-time lowpass or bandpass filter by providing a software design tool and a prototyping PC board complete with a MAX274 8th-order, continuous-time filter IC. Starting from your basic filter requirements, Maxim's Filter Design Software calculates filter order, poles, and Qs of classic filter types (Butterworth, Chebyshev, or Bessel), then calculates resistor values required to implement the complete filter. Installing these resistors on the PC board provided and cascading the required number of sections of the MAX274 filter yields a complete filter — ready for testing — eliminating the need for expensive and time-consuming prototyping. The MAX274 PC board layout may be incorporated directly in production PC boards for absolutely consistent results from prototype to production.

Feature

- ◆ **Allows You to Design and Build Lowpass or Bandpass Filters**
- ◆ **Pole Frequencies (Fo) from 100Hz to 150kHz**
- ◆ **Kit Supports Butterworth, Chebyshev, and Bessel Designs**
- ◆ **Includes Design Software:**
 - **Calculates filter order, poles, and Qs from your filter requirements**
 - **Plots filter responses — gain, phase, and group delay — for inspection BEFORE you build the filter**
 - **Calculates resistor values needed to build filter**
- ◆ **Includes PC Board for Evaluation:**
 - **PC board allows you to build filters immediately — simply install proper resistor values on board**
 - **Build up to 8th-order filters by cascading the four second-order sections — or use sections individually for multiple filters**
 - **Operates from single +5V or dual 5V supplies**

EV Kit

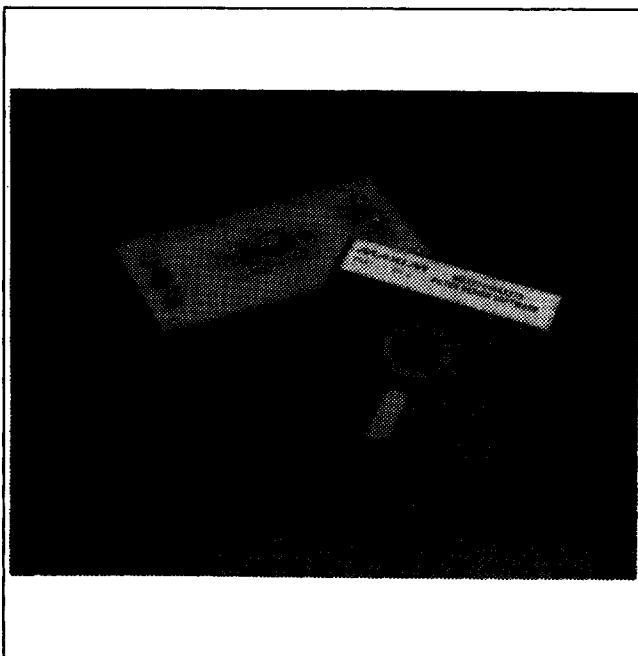

Figure 1. The MAX274 EV kit includes filter design software, PC board with MAX274 IC, and full documentation.

Ordering Information

PART	TEMP. RANGE	BOARD TYPE
MAX274EVKIT	0°C to +70°C	Plastic DIP – Through Hole

Component List

QUANTITY	COMPONENT	SYMBOL
1	MAX274ACNG Filter IC	None
1	MAX274 Filter Circuit PC Board	None
2	BNC Screw-In Connectors	None
3	Banana Jacks	None
4	Standoffs, 4-40 Screws	None
2	10 μ F/16V Dipped Tantalum Capacitors	C1, C4 or CS1
2	0.1 μ F Ceramic Capacitors	C2, C3
1	Filter Design Software on 5 1/4" Floppy Disk	None

4th- and 8th-Order Continuous-Time Active Filters

Filter Design Software

NOTE: CHECK FILE "README.DOC" FOR IMPORTANT CHANGES

Installation

You will need an IBM-compatible PC, DOS version 2.0 or later, with a 5 1/4" floppy disk drive, and one of the following video displays: Hercules graphics, CGA, EGA, VGA or compatible. Either a hard drive or an additional floppy drive is also required.

To install the program, insert the floppy into your disk drive and type "A:INSTALL" (or "B:INSTALL"). Follow the instructions on the screen. After installation, type "FILTER" to start the program. Be sure you are in the drive/directory where the software is installed.

Help

After installing the software, print a hard copy of the file FILTER.HLP by entering TYPE FILTER.HLP > PRN from DOS. This collection of help screens serves as the instruction manual for operating the software. Individual help screens may be printed while running the software by pressing F1, then following instructions on the screen.

Assembly Instructions

1. Install BNC connectors and banana jacks as shown in Figure 2. Connect wires from the V+, GND, and V- jacks to the nodes designated V+, GND, and V- on the circuit. Install MAX274 IC as shown (or install an IC socket if desired).
2. Install filter feedback resistors (R1A-R4A, R1B-R4B, R1C-R4C, R1D-R4D). The values of these resistors depend on the particular filter being built, and can be calculated from the data sheet or with the aid of Maxim's Filter Design Software. All resistors except RS1 and RS2 should be either carbon or metal-film type (not wire-wound).

If using resistor T-networks (described in the *High-Value Resistor Transformation* section of the MAX274 data sheet — denoted as R5_ - R10_ in the filter software), perform the following:

On the PC board, scratch off the green soldermask from the ground trace (Figure 2). Where required, substitute each normal resistor connection (R2, R3, or R4) with three T-network resistors on the underside of the board, using jumper wire to connect the T-network ground connection with the ground trace on the PC board (Figure 3).

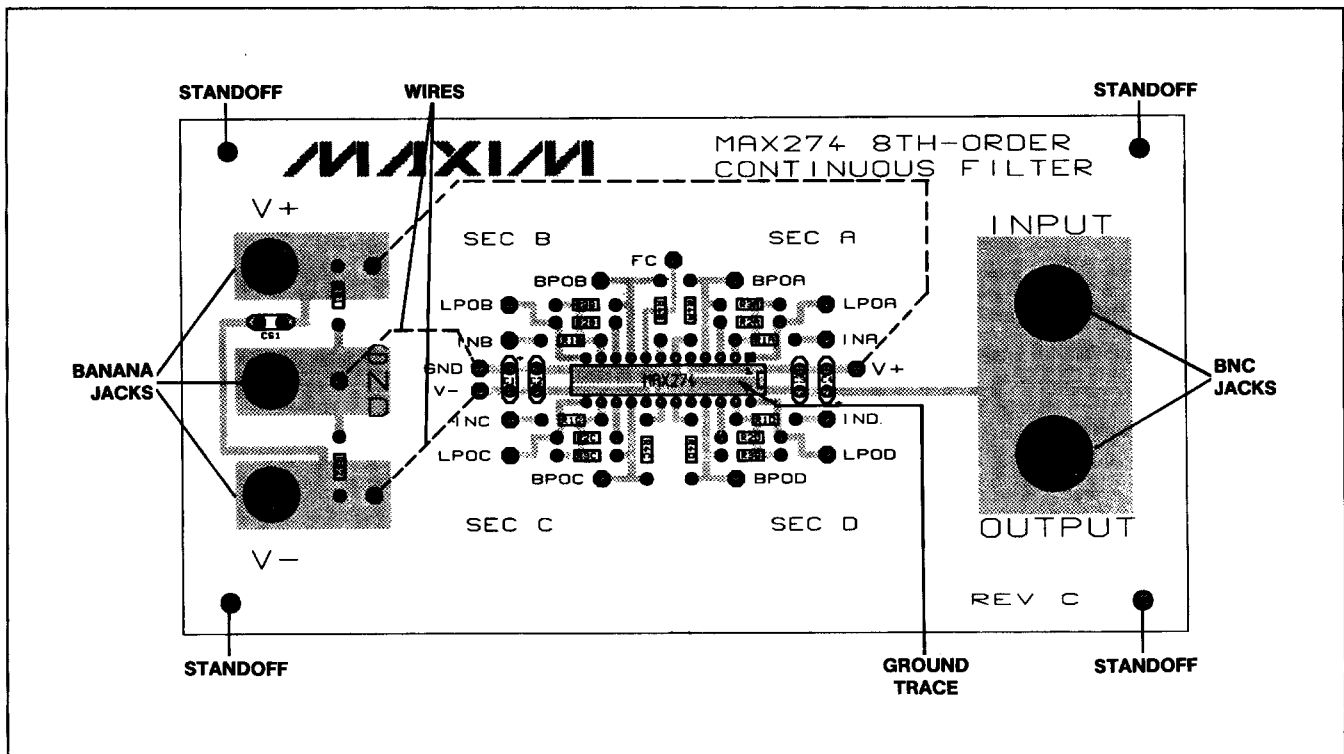

Figure 2. MAX274 EV Kit Component Placement Diagram

4th- and 8th-Order Continuous-Time Active Filters

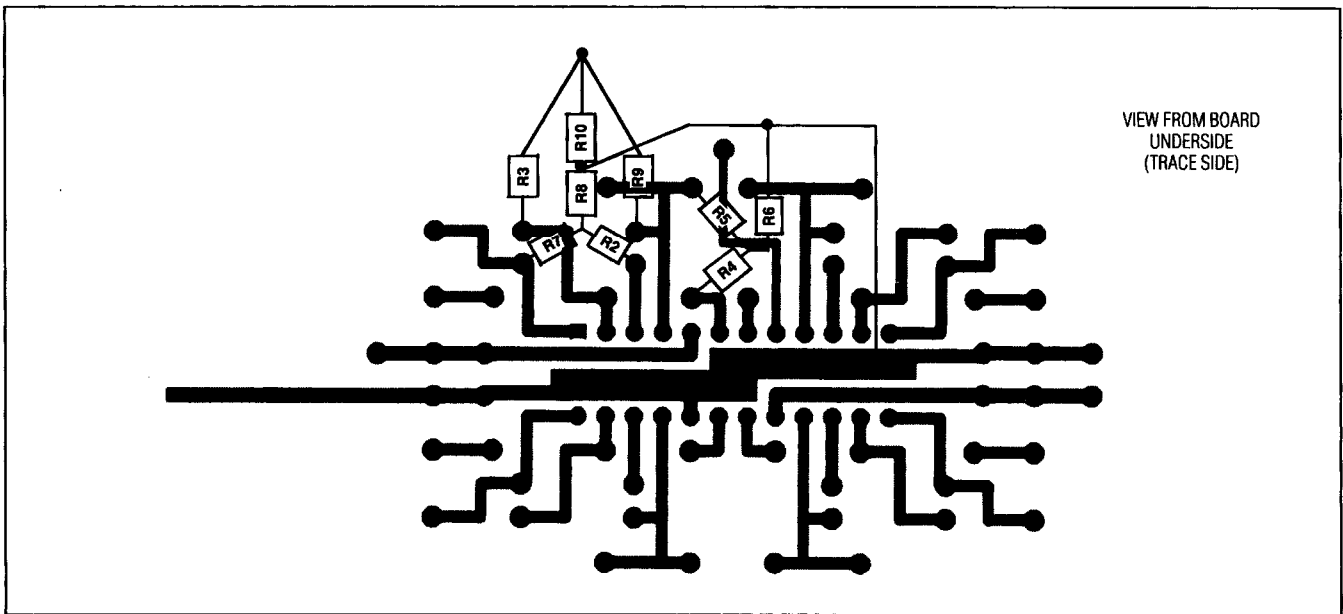

Figure 3. T-Network PC Board Connections

Recommended Resistor Sources

AVAILABLE TOLERANCES	TYPE	MANUFACTURER
1%, 0.1%, Others 5-100ppm/°C	Metal Film PTF Series	Dale 402-371-0800 FAX: 402-644-4206
1%, 0.1%	Surface Mount RN73H2B RN73E2B	KOA Speer 814-362-5536 FAX: 814-362-8883
1%, 0.1% to 2ppm/°C	PR, RL Series	Precision Resistive Products 319-394-9131 FAX: 319-394-9280

- BE SURE IC IS INSTALLED ON BOARD BEFORE POWER IS APPLIED. Single +5V or +10V operation: Install RS1 and RS2 (both 4.7kΩ). Install C1, C2, and CS1 - omit C3 and C4. Apply positive supply to V+, supply ground to V-. Do not connect any supply to GND. For dual supply (5V) operation, omit RS1 and RS2, and apply positive supply, negative supply, and ground to V+, V-, and GND respectively.
- Perform a frequency-response test for each filter section used (A,B,C, and D) to verify F_0/Q accuracy, before connecting them in series (cascading). For highest-accuracy results, perform frequency-response tests using a spectrum analyzer. Use the F_0 and Q measurement techniques described in the MAX274 data sheet in the *Measuring F_0 and Q* section. These methods apply to both lowpass and bandpass designs.

To measure filter section A's F_0 and Q , apply the test sweep signal at INA, measure BPOA. F_0 is the frequency at which INA and BPOA are exactly 180° out of phase. Q is determined by the formula:

$$Q = \text{FPK} / \text{-3dB bandwidth}$$

where FPK is the frequency at which the gain at BPOA is greatest (this may not be equal to F_0); and the -3dB bandwidth is the difference between the two frequencies at which BPOA is attenuated by 3dB from its peak gain. Repeat these measurements for filter sections B, C, and D. For more information, refer to Figure 2 of the MAX274 data sheet, *Bandpass Output*.

If the filter operates from a single supply, signals applied to the filters must be "centered" between V+ and V- so that signals remain in the common-mode range of the internal amplifiers.

- Cascade the filter sections (connect them in series) to produce the desired filter response. For example, for an 8th-order bandpass filter, use jumper wires to connect BPOA to INB, BPOB to INC, and BPOC to IND. Apply the signal input at INA; the filter output is taken at OUTD. If desired, connect the INPUT and OUTPUT BNC connectors to the input and output of the cascaded filter using jumper wires. For lowpass filters, cascade the sections using LPO_ as the outputs. For lower-order filters, omit unused sections; for higher than 8th-order filters, order additional MAX274 PC boards from Maxim to add the required number of sections.

4th- and 8th-Order Continuous-Time Active Filters

Maxim cannot assume responsibility for use of any circuitry other than circuitry entirely embodied in a Maxim product. No circuit patent licenses are implied. Maxim reserves the right to change the circuitry and specifications without notice at any time.

28 _____ **Maxim Integrated Products, 120 San Gabriel Drive, Sunnyvale, CA 94086 (408) 737-7600**